

EDGE PROTECTION SOLUTIONS

- | Tray Deck Bolt Down Structure
- | Steel Structural Structure
- | Stairway Structure
- | Insitu Formwork Structure
- | Temporary Enclosures
- | Short Pinning Excavation Works



CONTENTS

Everything your site needs

OUR SOLUTIONS	3
BOLT DOWN SYSTEM	4-5
EDGE BRACKET SYSTEM	6-7
SLAB CLAMP SYSTEM	8-9
ALUMINIUM BEAM SYSTEM	10-11
H20 TIMBER BEAM SYSTEM	12-13
SAFETY PROTECTION SYSTEM	14-15
COMPRESSION POST SYSTEM	16-17
CLAMP SYSTEMS	18-23
TRENCH GUARD SYSTEM	24-25
SAFETY NET SYSTEM	27
EPS COMPONENTS	28-32

We've got
New Zealand
covered

We also specialise in
supplying the Pacific:

FIJI | SAMOA | TONGA | CHATHAM ISLANDS
COOK ISLANDS | VANUATU | NIUE | NEW CALEDONIA

AUCKLAND
82 McLaughlins Rd,
Wiri

CHRISTCHURCH
115 Hayton Rd,
Wigram

WELLINGTON
3 Mohuia Cres,
Porirua



OUR SOLUTIONS

Thanks to our wide variety of engineered attachments for different scenarios, edge protection systems offer versatile applications. They can be used in concrete slab structures, steel structures, stairway systems, formwork, temporary enclosures, blocking, groundworks, and more.



TRAY DECK BOLT DOWN STRUCTURE

Can be installed by surface mounting, slab edge fixing options and non-drilled clamping attachments.



STEEL STRUCTURAL STRUCTURE

We offer engineered edge protection systems designed to meet the diverse safety demands of steelwork erection procedures.

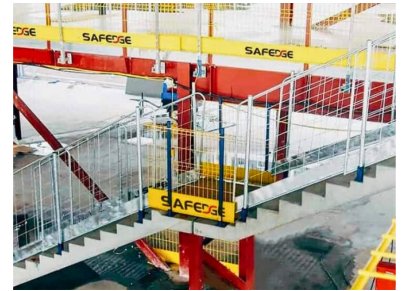

STAIRWAY STRUCTURE

EPS for staircases can be quickly installed by means of drilling and fixing, threaded inserts, prefabricated sockets or clamping.



INSITU FORMWORK STRUCTURE

Cleverly designed clips enable a quick-attach function, suitable for all sizes of aluminium beam profiles and timber beam profiles.



TEMPORARY ENCLOSURE

Our EPS system can be used as a temporary enclosure in traffic environments, construction sites, events etc.



SHORT PINNING EXCAVATION WORKS

Provides total solutions for all unprotected excavated areas. Suitable for sheet piles and trench boxes applications.

Slab edges are present everywhere and are a usual cause of fall accidents.

Edge protection can be installed on the slab or the outside of the slab edge. If there are columns, they can be an alternative attachment to the edge protection.

Powerpac Safedge Bolted down solution is by bolting the socket base to the top of the slab to set up a system.

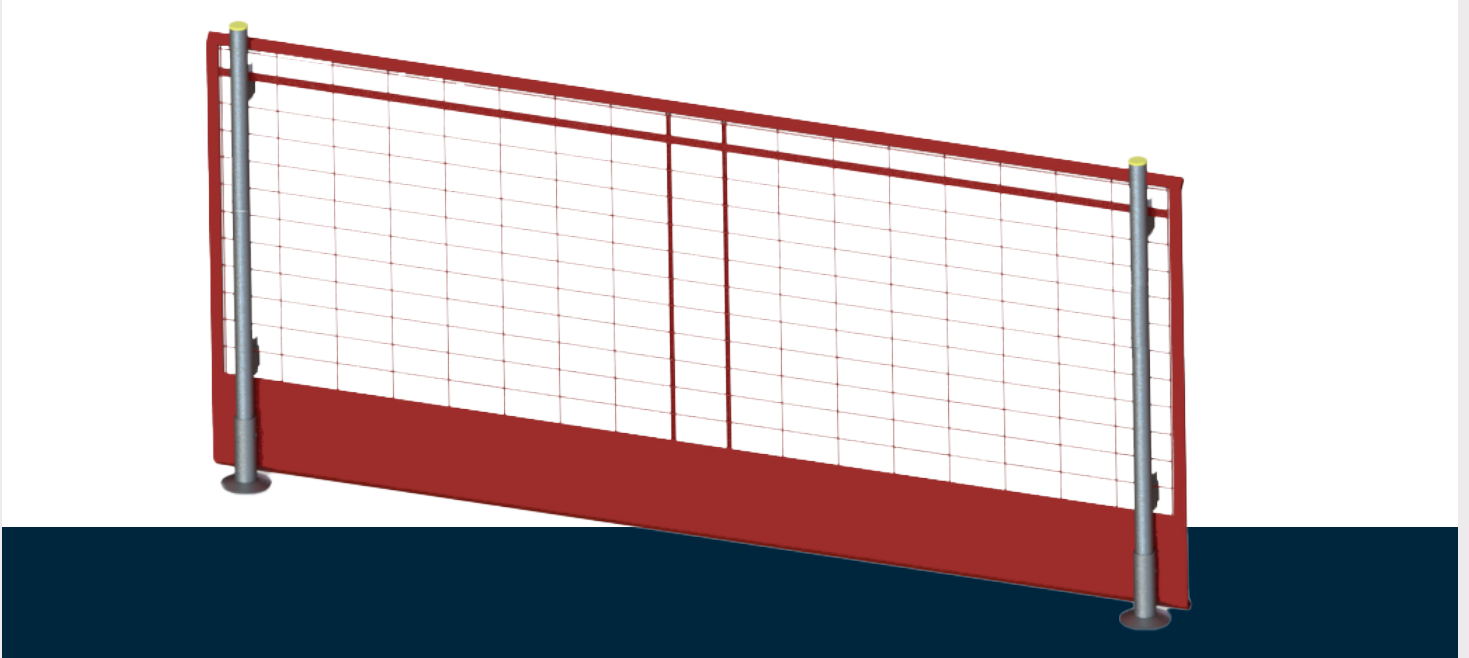

SOCKET BASE

SKU: 6210-101001

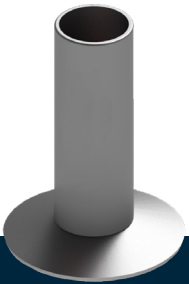

SAFEDGE POST 1.2m

SKU: 6210-101002

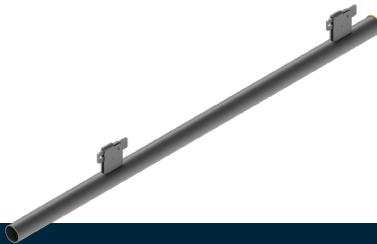

MESH BARRIER 2.6m

SKU: 6210-101003

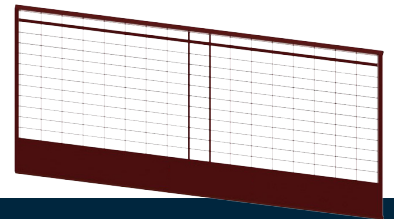

MESH BARRIER 1.3m

SKU: 6210-101004

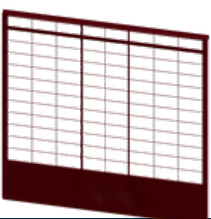

EXTENSION POST

SKU: 6210-101005

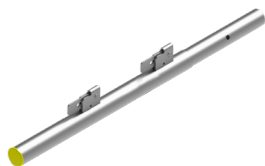

EXTENSION BARRIER 2.6m

SKU: 6210-101006



EXTENSION BARRIER 1.3m

SKU: 6210-101007

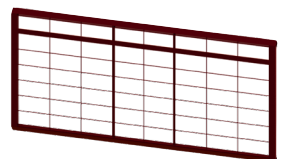

TG Bolt Down Edge Protection System is another fall protection system for concrete construction projects or Timber structures.

The system is developed and manufactured by Powerpac Builders Equipment in China.

THE COMPONENTS INCLUDE:

- TG Foot, Multi Foot,
- TG Mesh Barrier 2.6m,
- TG Mesh Barrier 1.3m,
- TG makeup Mesh Barrier 2.6m/1.3m,
- TG post 1.3m/1.9m, and
- TG Slider (also called TG Barrier Clip).

TG FOOT

SKU: 6210-101001



TG MESH BARRIER 2.6m

SKU: 6210-101023

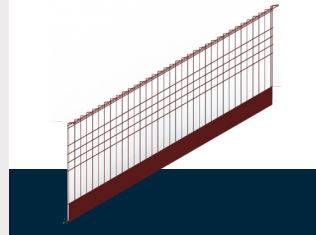

TG POST 1.3m & 1.9m

SKU: 6210-101012
SKU: 6210-101013

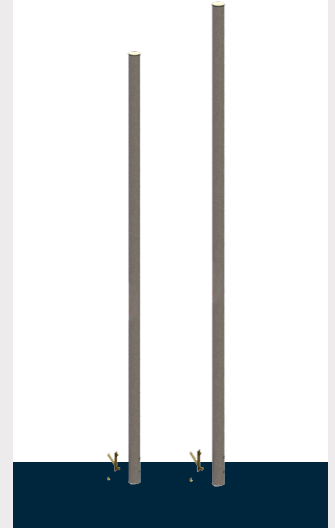

MULTI FOOT

SKU: 6210-101021



TG MESH BARRIER 1.3m

SKU: 6210-101024

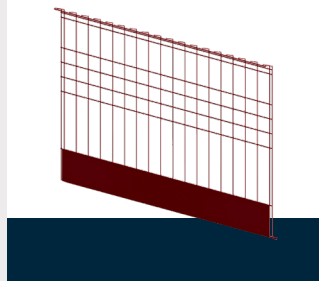

MAKE UP MESH BARRIER 1.3m

SKU: 6210-101026

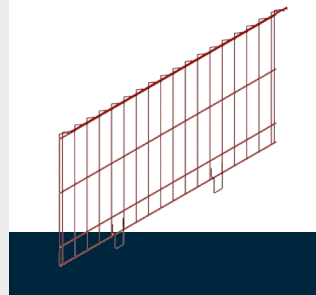

MAKE UP MESH BARRIER 2.6m

SKU: 6210-101025

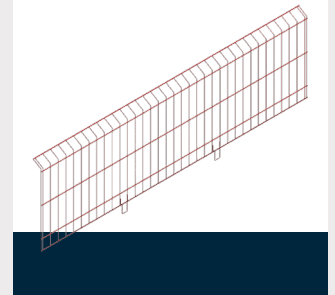

TG SLIDER (MESH BARRIER)

SKU: 6210-101023

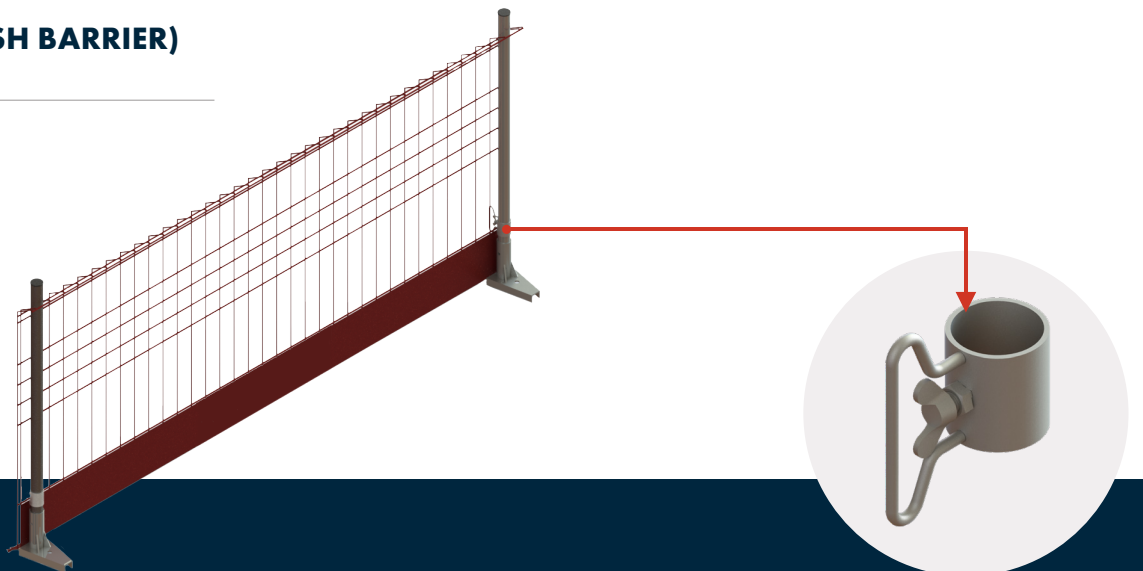

Adjustable Slab Edge Brackets are the key elements of safedge edge bracket system.

The adjustable slab edge brackets can be mounted to the side edge of the slab, using together with safedge post 1.2m, safedge mesh barrier 2.6m/1.3m to offer fall protection on the slab edge.

Safedge extension posts, safedge extension mesh barriers 2.6m/1.3m are available for a total 1.8m protection height.

ADJUSTABLE SLAB EDGE BRACKET

SKU: 6210-101032

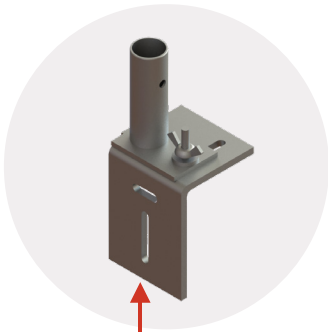

SAFEDGE POST 1.2m

SKU: 6210-101002

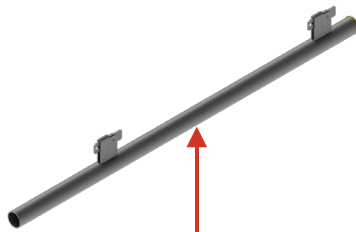

MESH BARRIER 2.6m

SKU: 6210-101003

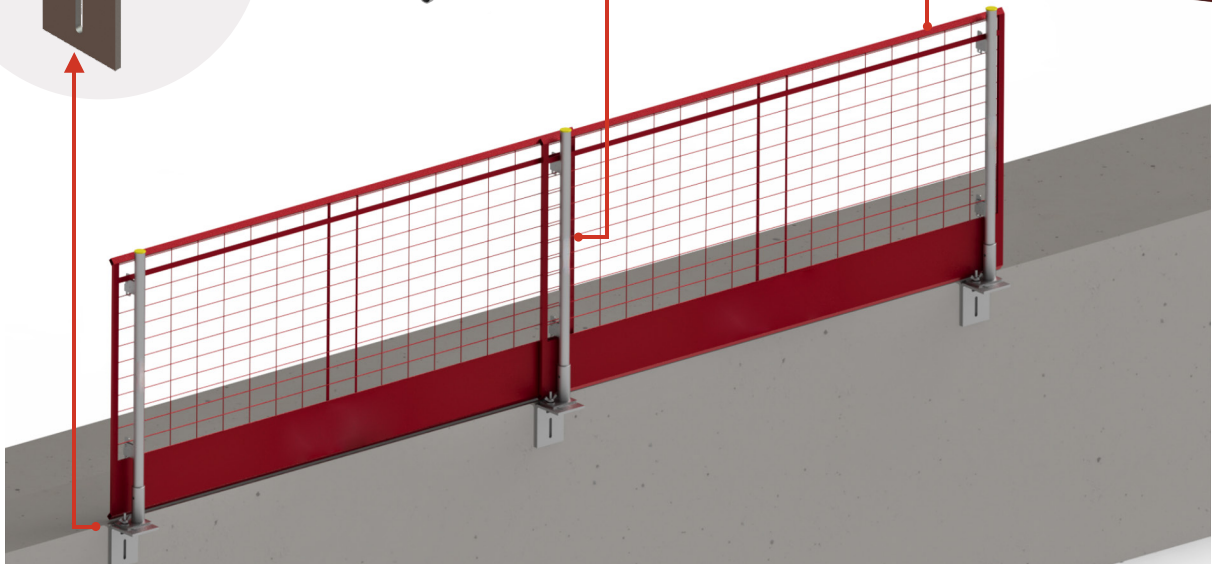
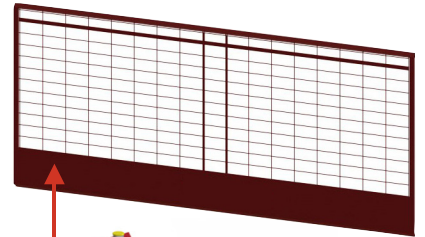

MESH BARRIER 1.3m

SKU: 6210-101004

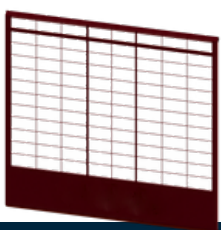

EXTENSION BARRIER 2.6m

SKU: 6210-101006

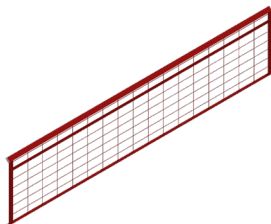

EXTENSION BARRIER 1.3m

SKU: 6210-101007

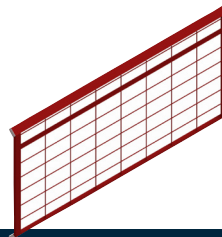

EXTENSION POST

SKU: 6210-101005



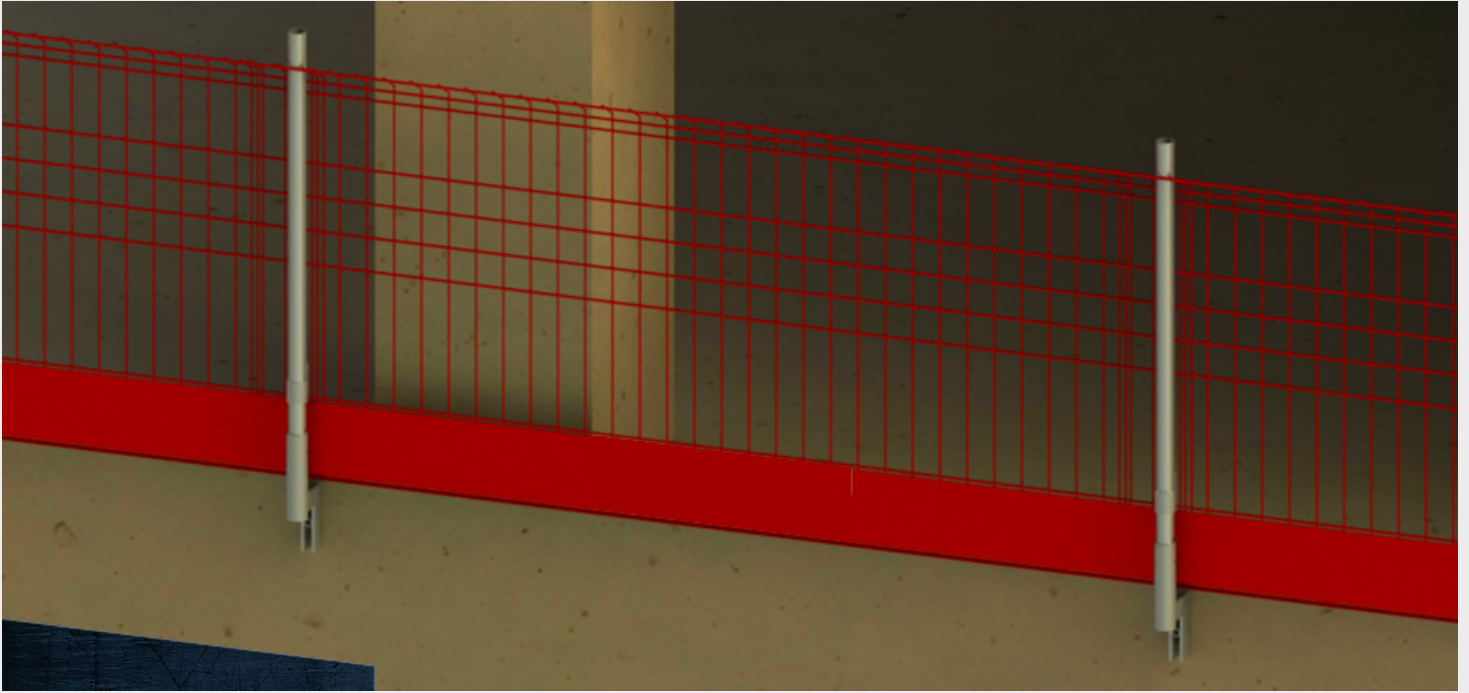

TG Edge Bracket units can be used over the slab or fixed away from the slab edge for internal brickwork concourse levels.

Powerpac TG EDGE BRACKET positions the Post 100mm off the face, providing access for edge finishing to be completed safely. Fitted using a single fixing, the edge bracket remains stable by spiking the concrete when tightened.

MAKEUP MESH BARRIER 1.3m

SKU: 6210-101026

EDGE BRACKET

SKU: 6210-101011

MAKEUP MESH BARRIER 2.6m

SKU: 6210-101025

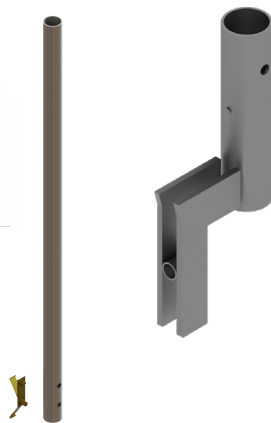
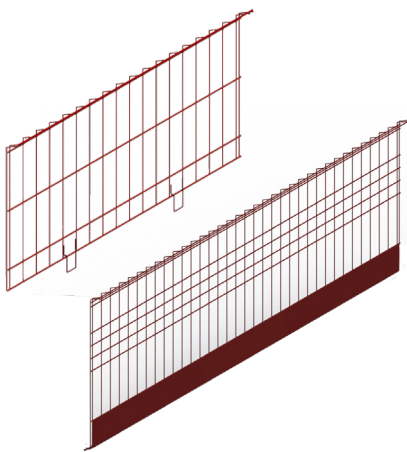

MESH BARRIER 2.6m

SKU: 6210-101023

TG POST 1.3m & 1.9m

SKU: 6210-101012
SKU: 6210-101013

MESH BARRIER 1.3m

SKU: 6210-101024

SLIDER (BARRIER CLIP)

SKU: 6210-105003

Multi Slab Clamp is the key element of Safedge Slab Clamp System. By using this Multi Slab clamp the process of making holes is eliminated when installing edge protection.

The Multi Slab Clamp can be swivelled and turned around and be installed in one simple operation without damaging the sensitive surface. The safedge posts will be fixed to the multi slab clamps to set the safedge mesh barriers.

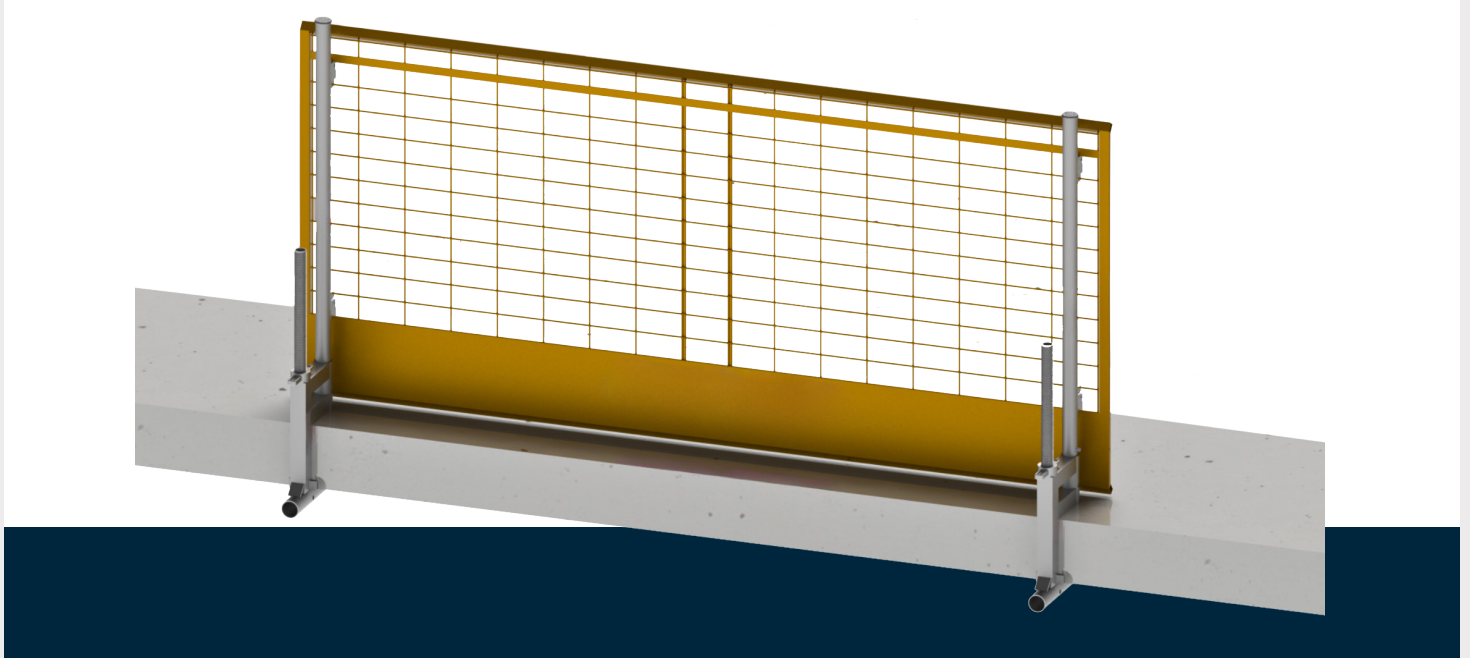

MULTI SLAB CLAMP

SKU: 6210-101008



SAFEDGE POST 1.2m

SKU: 6210-101002



MESH BARRIER 2.6m

SKU: 6210-101003

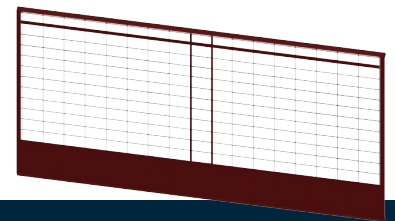

MESH BARRIER 1.3m

SKU: 6210-101004

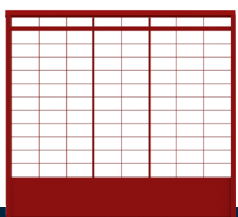

EXTENSION POST

SKU: 6210-101005

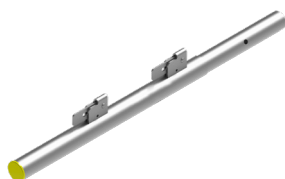

EXTENSION BARRIER 2.6m

SKU: 6210-101006

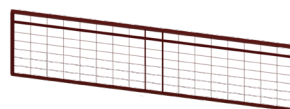

EXTENSION BARRIER 1.3m

SKU: 6210-101007

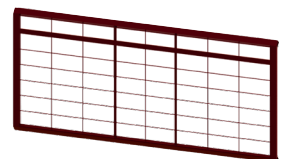

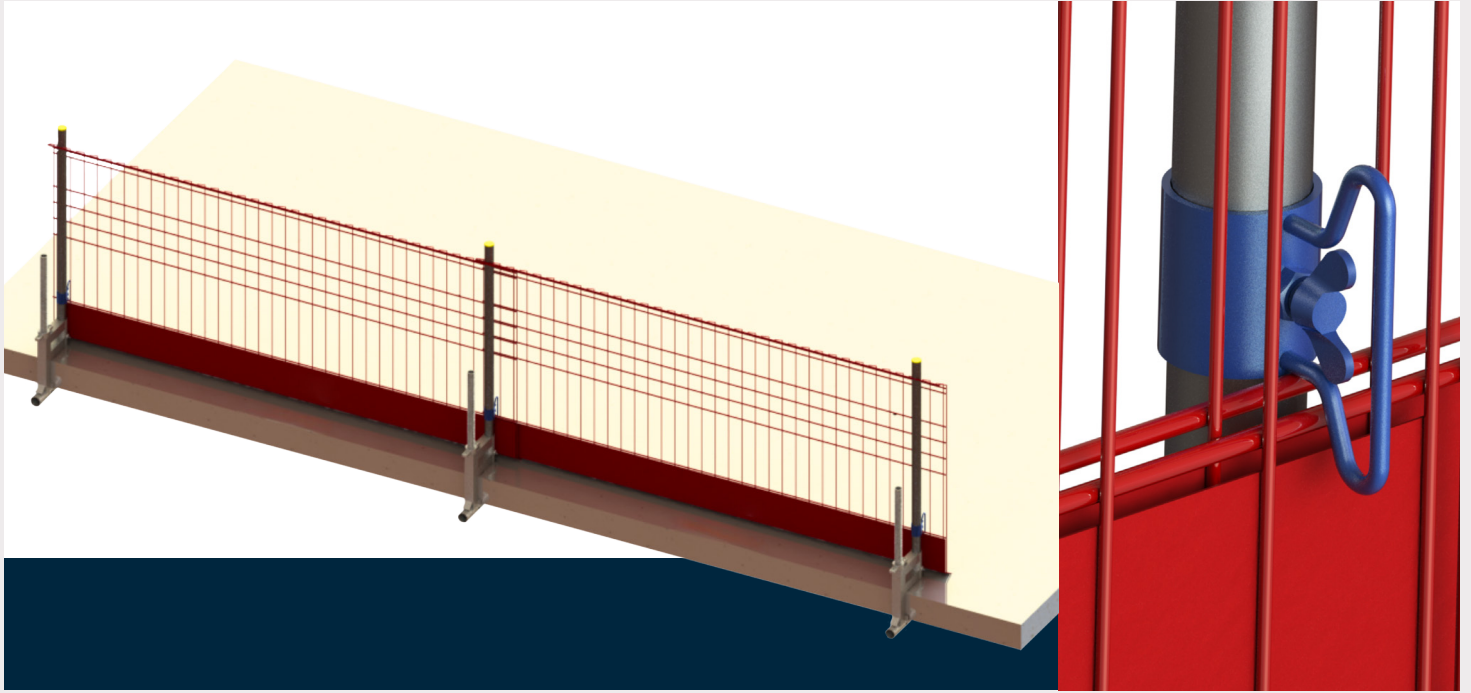

TG Slab Clamp System uses the same multi slab clamp as Safedge Clamp System. The Multi slab Clamp offers both horizontal and vertical clamping options and can be quickly set to a maximum of 450mm using the welded O.D 38 thread and tightened securely with a hammer.

The TG Slab Clamp System covers a wide range of applications and is perfect for applications where drilling into floor slabs is prohibited.

MAKEUP MESH BARRIER 1.3m

SKU: 6210-101026

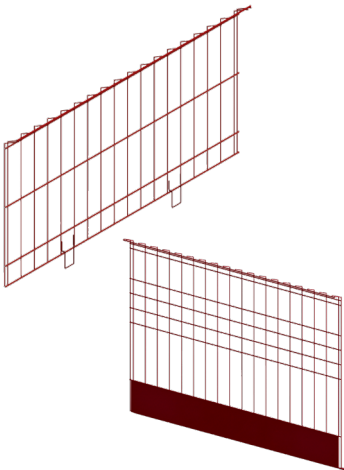

MESH BARRIER 1.3m

SKU: 6210-101024

MESH BARRIER 2.6m

SKU: 6210-101023

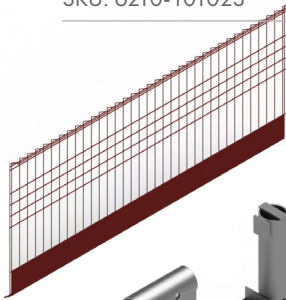

MULTI SLAB CLAMP

SKU: 6210-101008

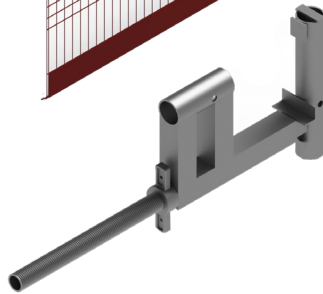

MAKEUP MESH BARRIER 2.6m

SKU: 6210-101025

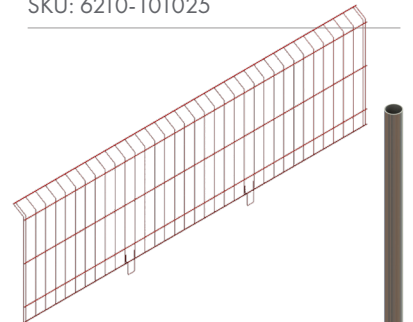

TG POST 1.3m & 1.9m

SKU: 6210-101012

SKU: 6210-101013



TG SLIDER (BARRIER CLIP)

SKU: 6210-105003

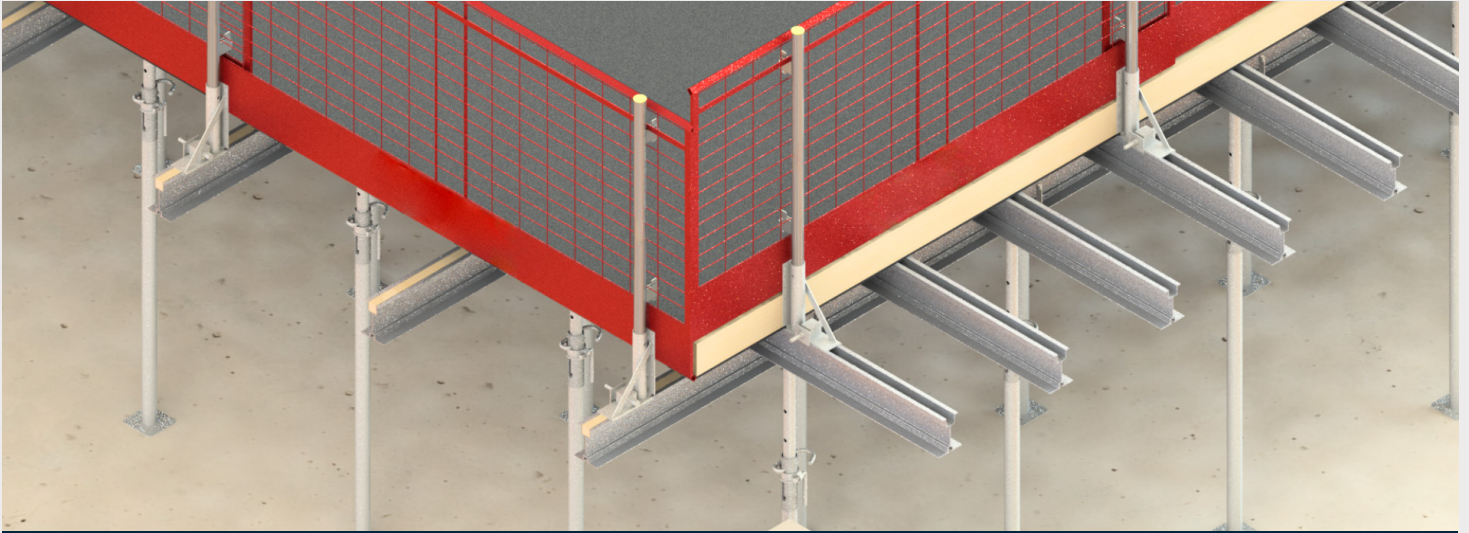

Safedge Aluminium Beam System consists of Adjustable Aluminium Beam Clamps, Safedge post, Safedge Mesh Barrier, and timber board for the primary aluminium beam.

The Adjustable Aluminium Beam Clamps are designed to fit the required load criteria imparted on Formwork decking system arrangements.

ALUMINIUM BEAM CLAMP

SKU: 6210-106001

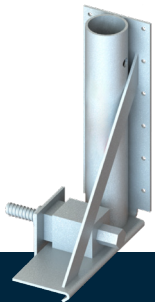

SAFEDGE POST 1.2m

SKU: 6210-101002



MESH BARRIER 2.6m

SKU: 6210-101003

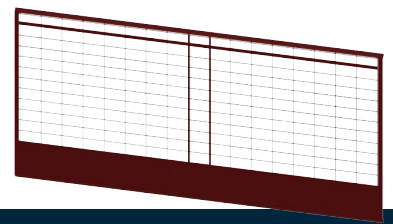

EXTENSION POST

SKU: 6210-101005

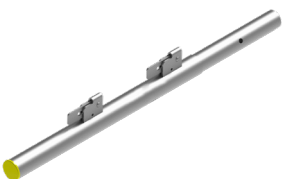

MESH BARRIER 1.3m

SKU: 6210-101004

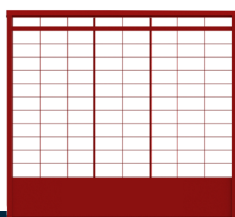

EXTENSION BARRIER 1.3m

SKU: 6210-101007

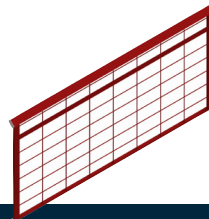

EXTENSION BARRIER 2.6m

SKU: 6210-101006

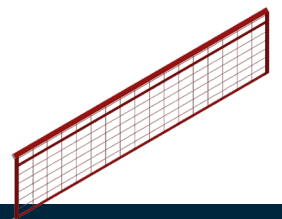

TG Aluminium beam system consists of Adjustable Aluminium Beam Clamps, TG posts, TG sliders and TG mesh barriers. The Aluminium Beam clamp is designed to meet the different beam sizes 60mm to 150mm in width. Powerpac has engineered the H20 Beam Clamps to fit 40mm & 60mm H20 beams. Compatible with European proprietary timber beam sections.

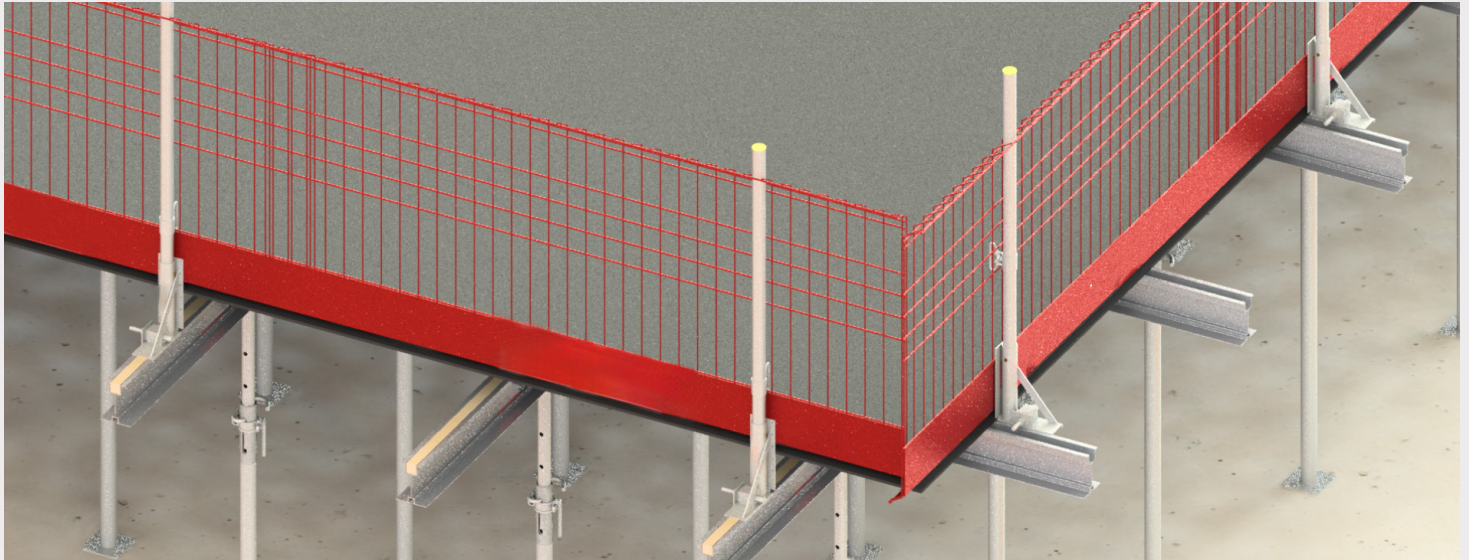

MAKEUP MESH BARRIER 1.3m

SKU: 6210-101026

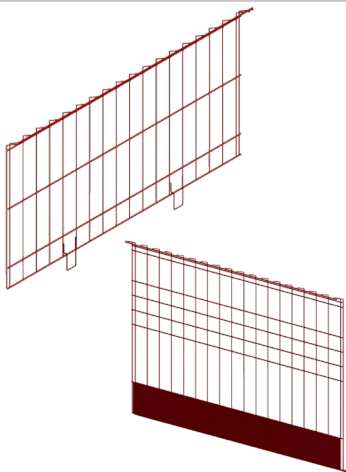

MESH BARRIER 1.3m

SKU: 6210-101024

MESH BARRIER 2.6m

SKU: 6210-101023

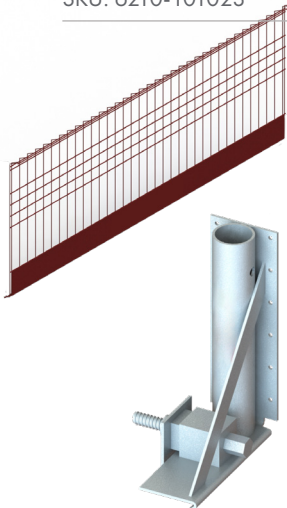

ALUMINIUM BEAM CLAMP

SKU: 6210-106001

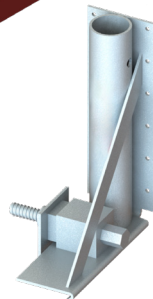

TG SLIDER (BARRIER CLIP)

SKU: 6210-105003



MAKEUP MESH BARRIER 2.6m

SKU: 6210-101025

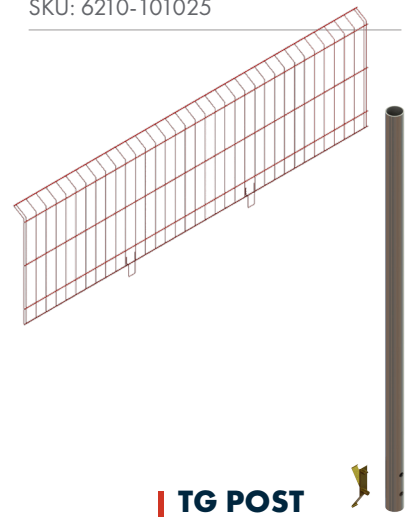

TG POST 1.3m & 1.9m

SKU: 6210-101012

SKU: 6210-101013



Safedge H20 Timber Beam System consists of H20 Timber Beam Clamps, Safedge post, Safedge mesh barrier. The H20 Beam clamp is designed to meet the required load criteria imparted on Formwork decking system arrangements. If you want to settle the H20 Timber beam clamps to the secondary beams, the Primary H20 Beam Socket is your best choice to extend the safedge post height.

H20 TIMBER BEAM CLAMP

SKU: 6210-106002



SAFEDGE POST 1.2m

SKU: 6210-101002



MESH BARRIER 2.6m

SKU: 6210-101003

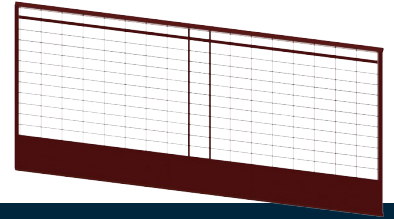

EXTENSION POST

SKU: 6210-101005



MESH BARRIER 1.3m

SKU: 6210-101004

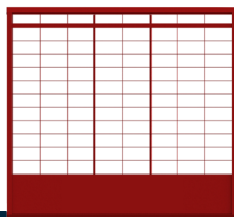

EXTENSION BARRIER 1.3m

SKU: 6210-101007

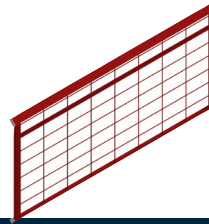

EXTENSION BARRIER 2.6m

SKU: 6210-101006

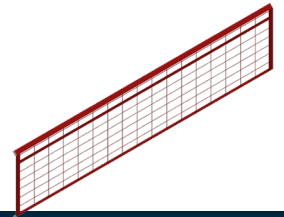

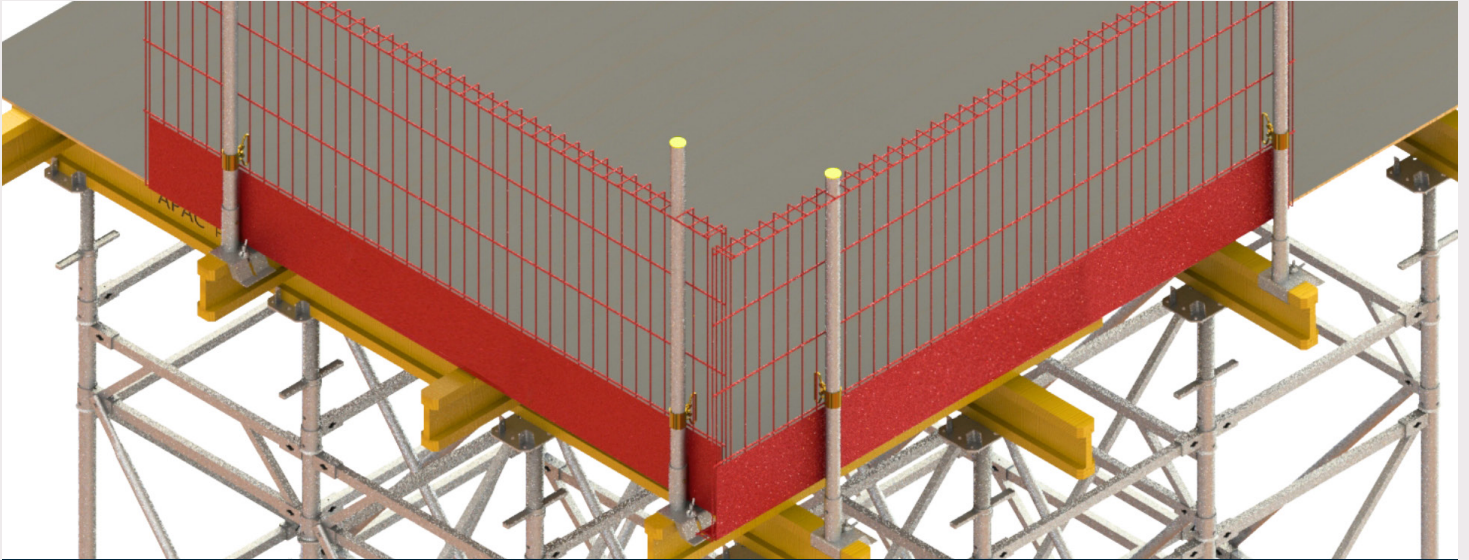

TG H2O Timber beam system consists of H2O Timber Beam Clamps, TG posts, TG sliders, and TG mesh barriers. The H2O Beam clamp is designed to meet the required load criteria imparted on Formwork decking system arrangements. Powerpac has engineered the H2O Beam Clamps to fit 40mm & 60mm H2O beams. Compatible with European proprietary timber beam sections.

MAKEUP MESH BARRIER 1.3m

SKU: 6210-101026

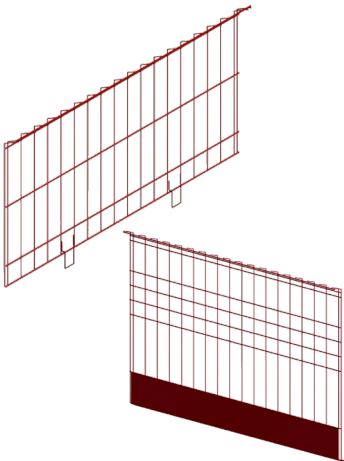

MESH BARRIER 1.3m

SKU: 6210-101024

MESH BARRIER 2.6m

SKU: 6210-101023

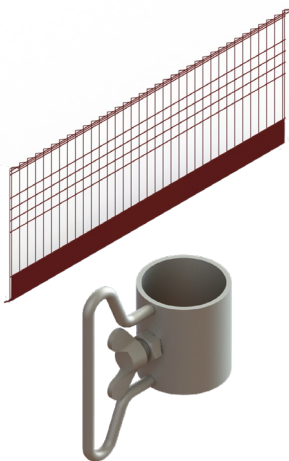

TG SLIDER (BARRIER CLIP)

SKU: 6210-105003

MAKEUP MESH BARRIER 2.6m

SKU: 6210-101025

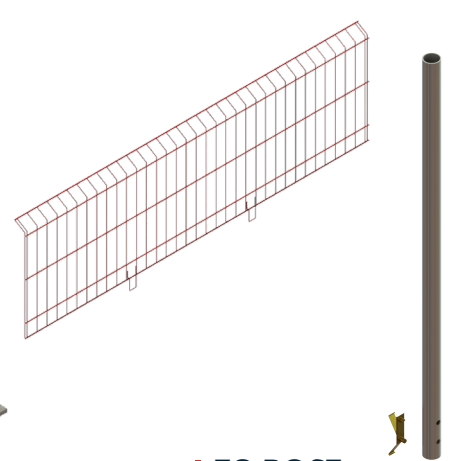

TG POST 1.3m & 1.9m

SKU: 6210-101012
SKU: 6210-101013

H2O TIMBER BEAM CLAMP

SKU: 6210-106002

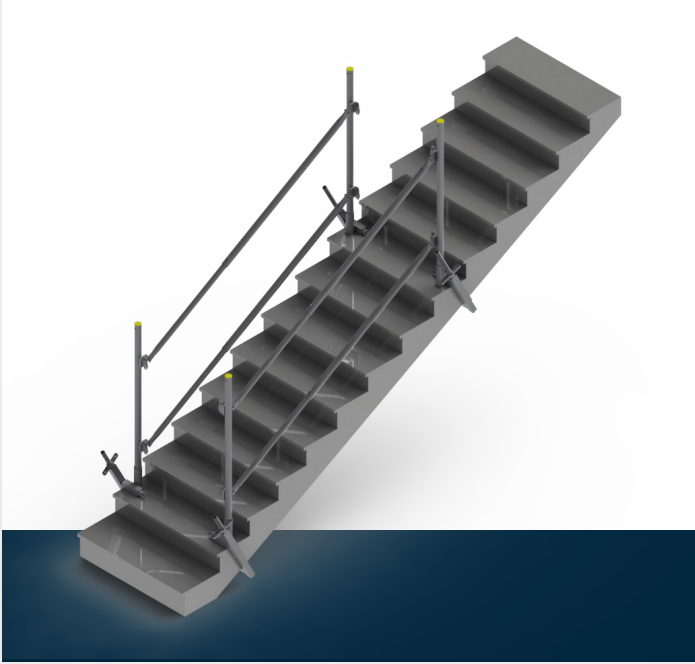

Powerpac Builders Equipment manufactures custom stair edge protection systems with form-fitting edges of stairs. These are highly made for construction sites.

We have temporary stairwell edge protection systems with handrails or barriers for you.

STAIR CLAMP

SKU: 6210-101018



SOCKET BASE

SKU: 6210-101001

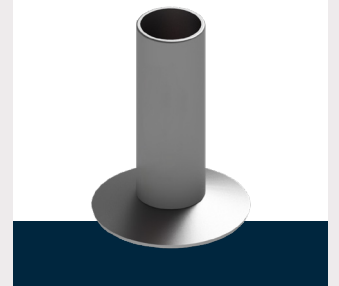

SAFEDGE POST 1.2m

SKU: 6210-101002

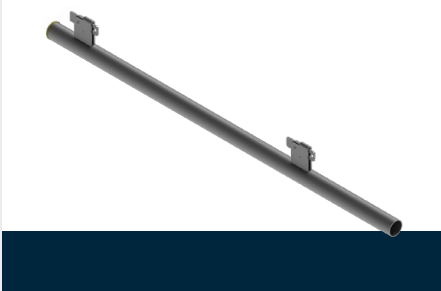

STAIR MESH BARRIER

SKU: 6210-105001

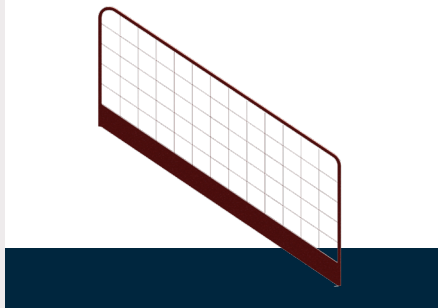

ADJUSTABLE LINK BAR 0.6m - 3.5m

SKU: 6210-105004 - 0.6m - 0.8m
SKU: 6210-105005 - 0.9m - 1.5m
SKU: 6210-105006 - 1.5m - 2.5m
SKU: 6210-105007 - 2.4m - 3.5m



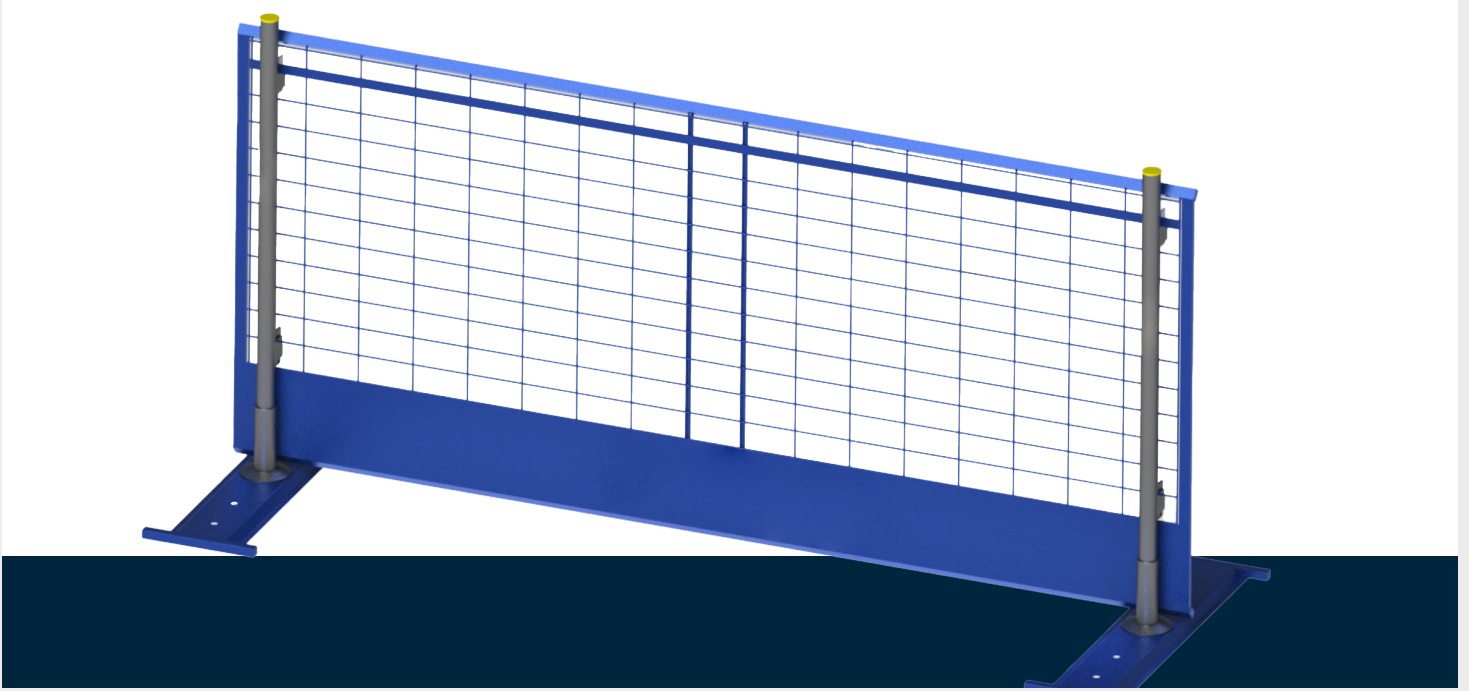

The provision for safe site walkways and non-pedestrian-zoned areas on site is a major site safety issue. Powerpac has tailored our commitment to this area by developing a walkway system that offers durability and strength, great flexibility, and the ability to be adapted to suit the most complex of site access areas.

WALKWAY FOOTPLATE

SKU: 6210-101031

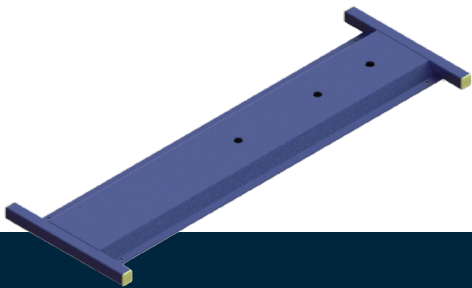

SAFEDGE POST 1.2m

SKU: 6210-101002



SOCKET BASE

SKU: 6210-101001

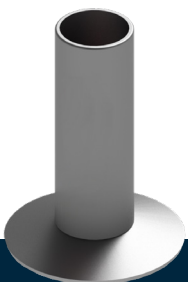

MESH BARRIER 2.6m

SKU: 6210-101003

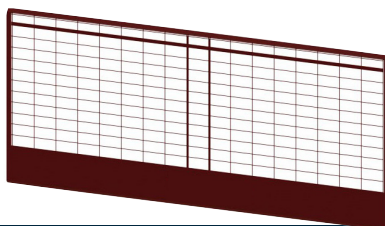

MESH BARRIER 1.3m

SKU: 6210-101004

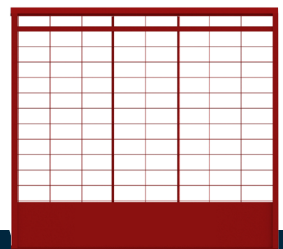

Compression Post Systems are used to install edge protection between concrete slabs and in other situations on construction sites. They are mainly used in concrete floors and soffits, but can also be provided for fixing some steel frames.



UNKNOWN

SKU: 6210-CPSTIL

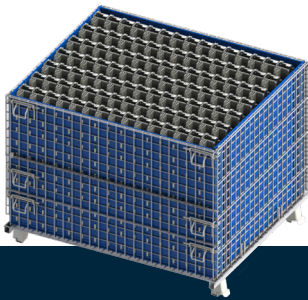

COMPRESSION POST BARRIER CLIP

SKU: 6210-101060



In order to facilitate transportation, stacking, and lifting of safeedge compression posts, the posts are transported by using stackable racks and the barrier clips will be packed into the box crates.

FEATURES:

- No tooling and no drilling are required
- Engineered secure lock mechanism, easy to handle
- Strong design, max safe load of 150kg
- Built-in visual gauge

UNKNOWN

SKU: 6210-CPTSTIL

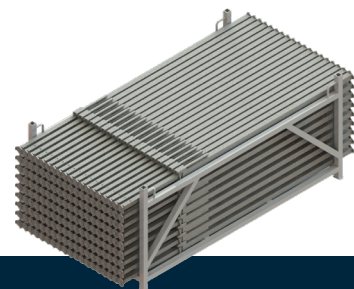

The COMPRESSION POST fixes between concrete floors and soffits without anchors to provide safe and rapid installation of edge protection. The COMPRESSION POST can be mechanically anchored to both slab and soffit in areas of extreme wind loading such as high-rise developments.

The Compression Post is a safety edge protection post used on concrete residential structures installed from floor to Ceiling. Quick and easy to erect, it offers up to the 3.5m (11'6") floor soffit full containment (Compression Post XL is available to 4.5m height).

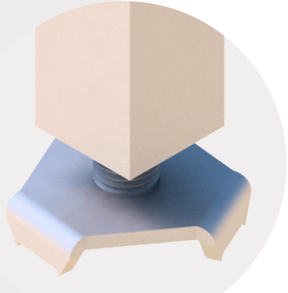

Anchor claw increases the friction and allows the post to be firmly fixed to the slabs.



Engineered handle mechanism design makes installation very easy to operate, no tooling and no drilling required



The spring mechanism allows the post to be compressed between the floor slabs and the vision gauge ensures that no full compression occurs.

COMPRESSION POST

SKU: 6210-102011 - 2.3m - 3.5m

SKU: 6210-102012 - 3.3m - 4.7m

When sliding the adjustment handle at Final position, the spring will be compressed then make the top plate come down toward the inner tube.

* View the inspection gauge. In the event it is showing any RED, rotate the post counter clockwise until the RED is no longer visible..



Slide the adjustment handle down so the ring sits against the outer tube



Final Position

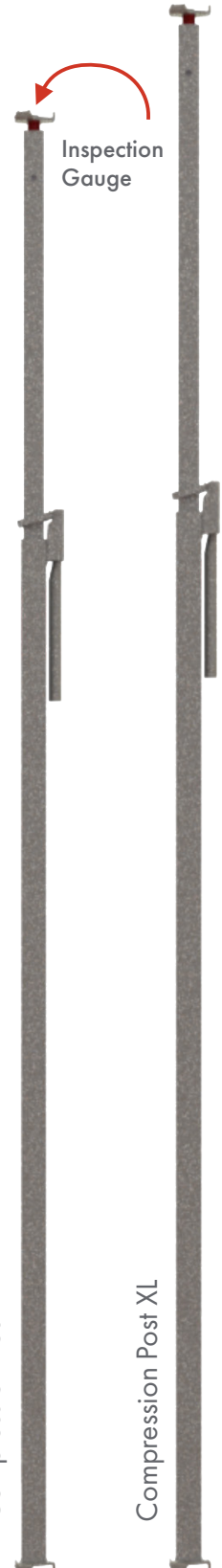

Compression Post

Compression Post XL

I Beam Facade Bracket System is designed for the fixing of edge protection systems for steel structures.

Safedge I beam facade bracket system consists of safedge posts, safedge mesh barriers 2.6m/1.3m and I Beam Facade brackets.

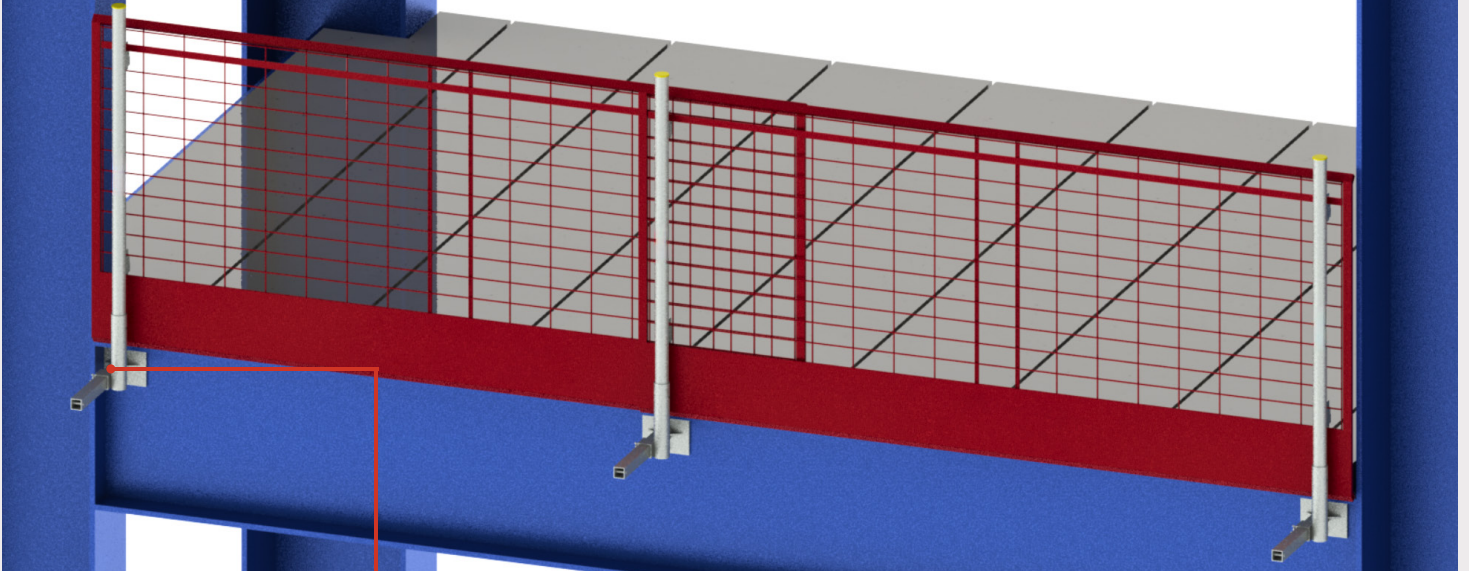

I BEAM FACADE BRACKET

SKU: 6210-103002



SAFEDGE POST 1.2m

SKU: 6210-101002

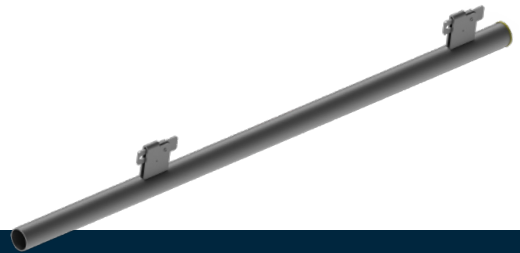

MESH BARRIER 1.3m

SKU: 6210-101004

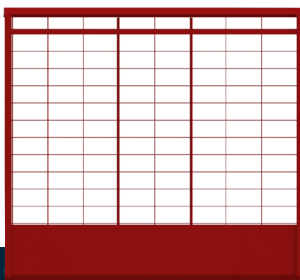

MESH BARRIER 2.6m

SKU: 6210-101003

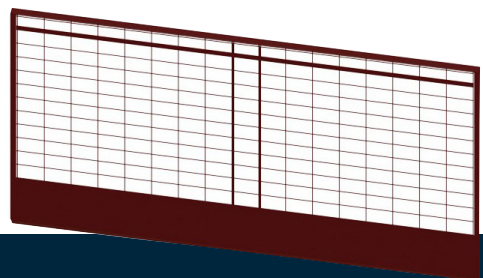

TG I beam facade bracket system consists of I beam facade brackets, TG posts, TG sliders, and TG mesh barriers 2.6m or 1.3m.

This Bracket is mounted to the surface of the I Beam web, integrated into the Safety Posts, and can be adjustable horizontal to fit different I Beam installation tasks.

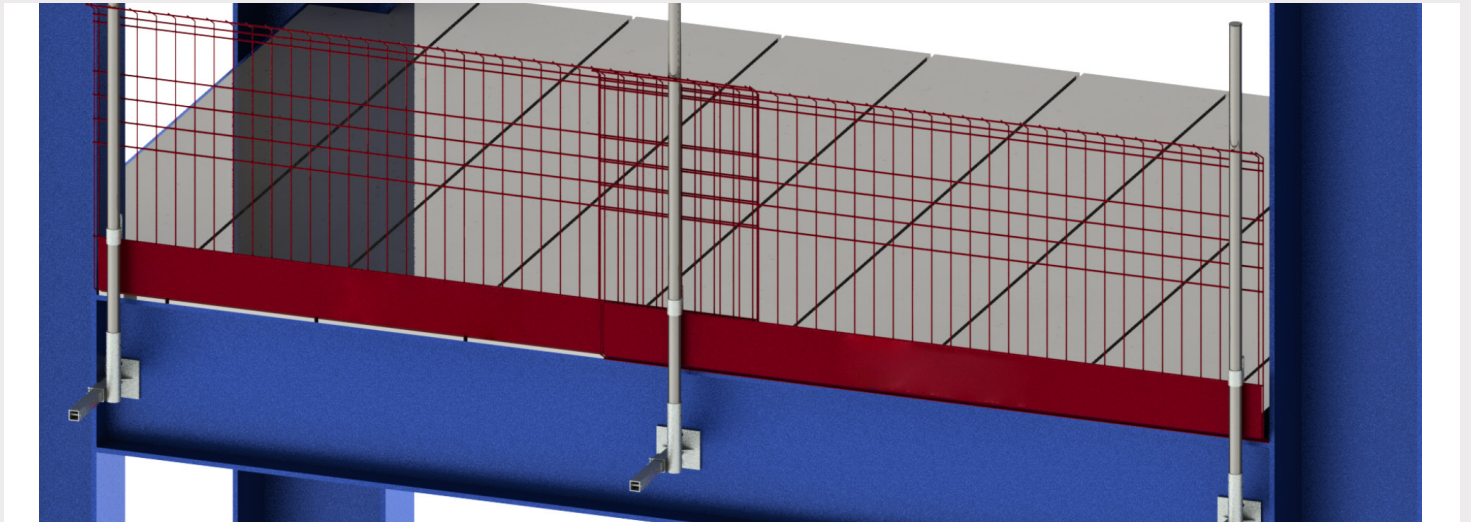

BEAM FACADE BRACKET

SKU: 6210-101023

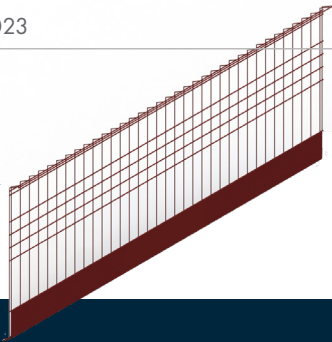

I BEAM FACADE BRACKET

SKU: 6210-103002



TG POST 1.9m

SKU: 6210-101013



MESH BARRIER 1.3m

SKU: 6210-101024

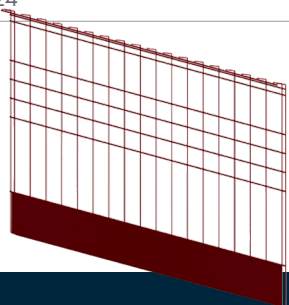

SLIDER (BARRIER CLIP)

SKU: 6210-105003



The I-Beam Clamp Barrier edge protection also called flange clamp edge protection, the system is extremely flexible. It does not rely on physical fixing. Therefore, it does not require any fixing holes or sacrificial sockets.

1.2m extension flute is designed to suit steel beams to a max height of 1000mm by Powerpac.

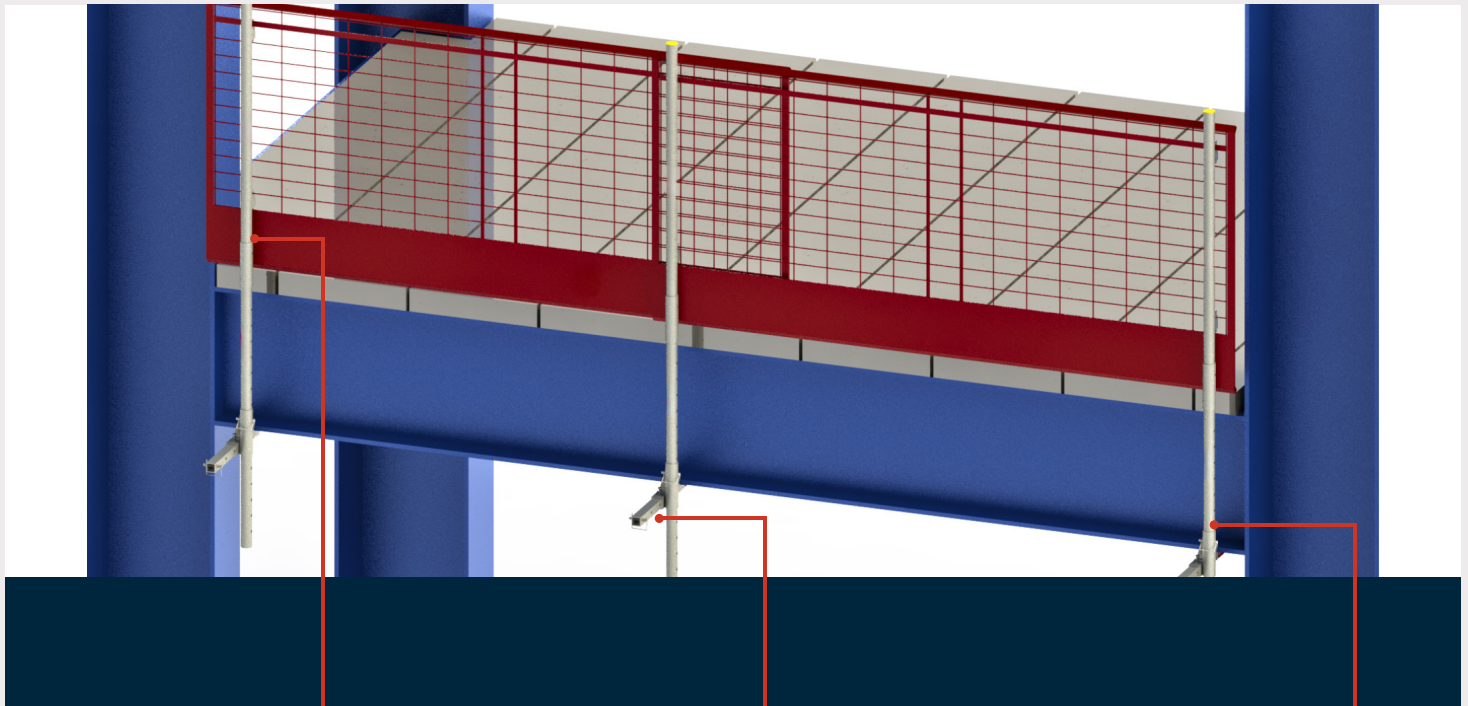

SAFEDGE POST 1.2m

SKU: 6101-101002

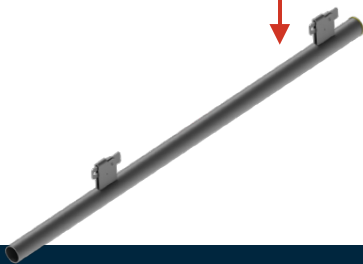

I BEAM CLAMP

SKU: 6101-103001

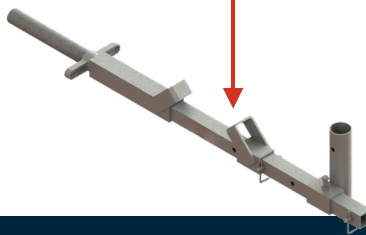

1.2m EXTENSION FLUTE

SKU: 6210-103003

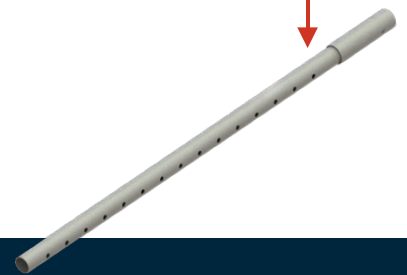

MESH BARRIER 2.6m

SKU: 6210-101003

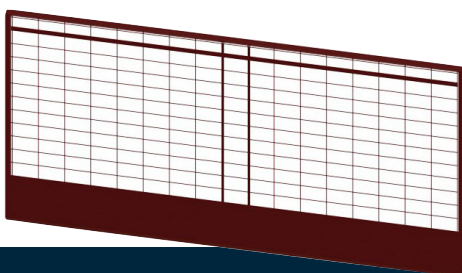

MESH BARRIER 1.3m

SKU: 6210-101004

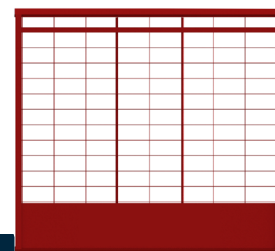

TG I beam clamp system consists of I beam clamps, TG posts 1.9m, TG sliders, and TG mesh barrier 2.6m or 1.3m. Powerpac's steel I-beam clamp has screw jacks welded to the body to ensure that it can be adapted to fit I-beams from 100 mm to 310 mm in width.

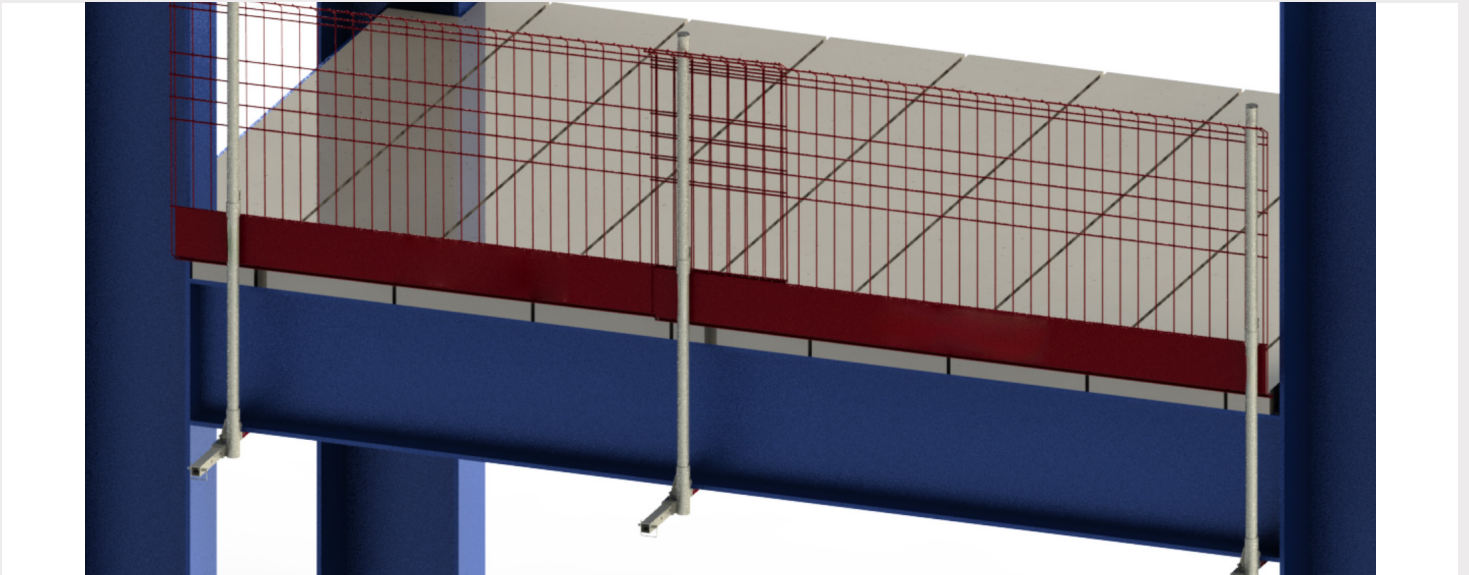

MESH BARRIER 2.6m

SKU: 6210-101003

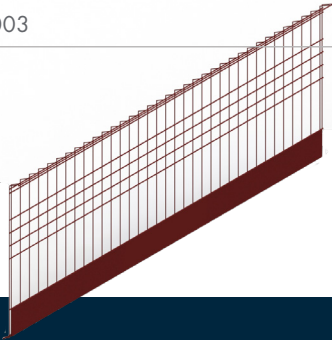

MESH BARRIER 1.3m

SKU: 6210-101024

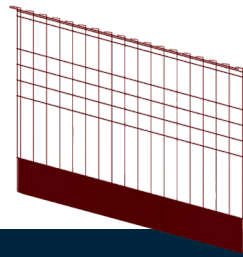

TG POST 1.9m

SKU: 6210-101013



I BEAM CLAMP

SKU: 6210-101002

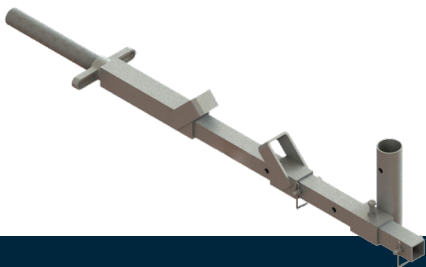

SLIDER (BARRIER CLIP)

SKU: 6210-105003



Safedge sheet pile clamp system is used sheet pile clamps to attach the sheet piles. When combined with the safedge posts, and safedge mesh barrier 2.6m or 1.3m offers the best edge protection solution.

The sheet pile clamp is adjustable to fit all standard sheet pile sizes and is impact set for quick application.

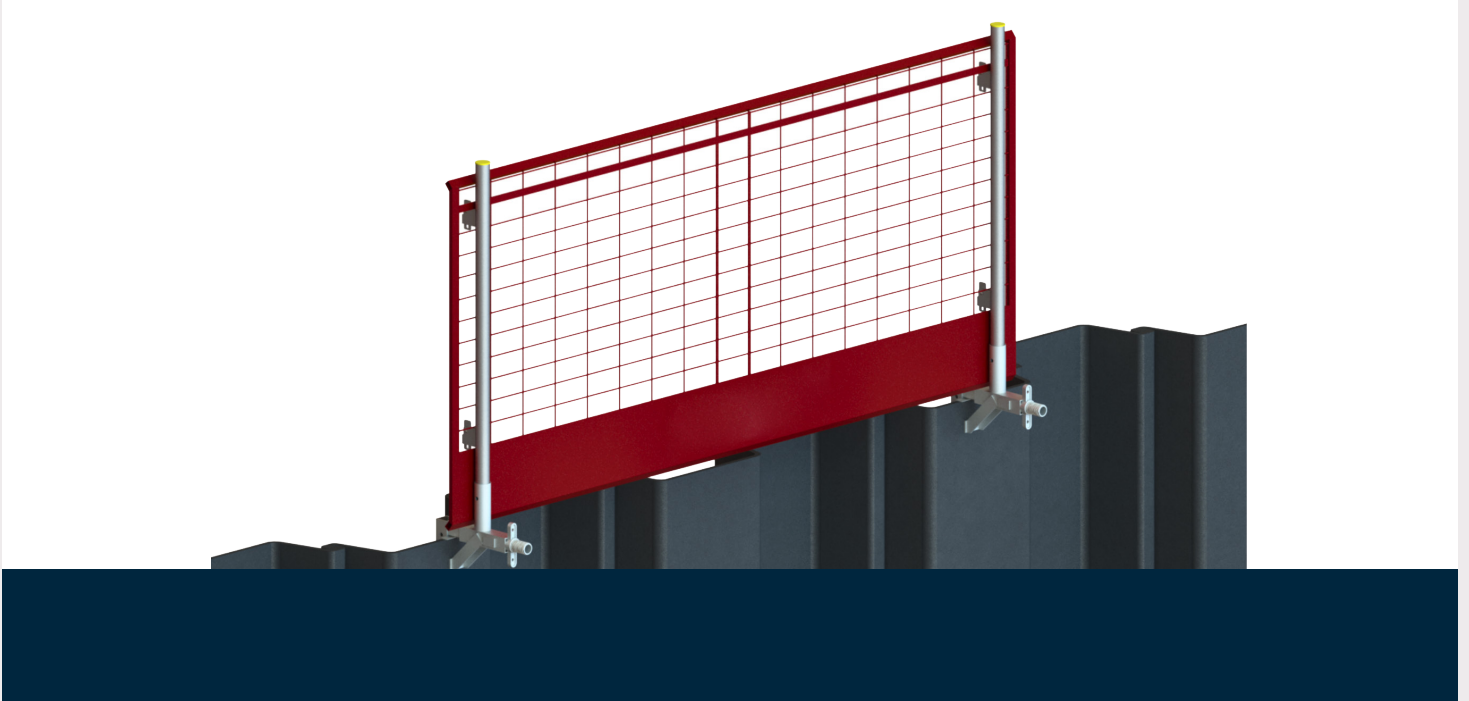

SHEET PILE CLAMP

SKU: 6210-106004



SAFEDGE POST 1.2m

SKU: 6101-101002

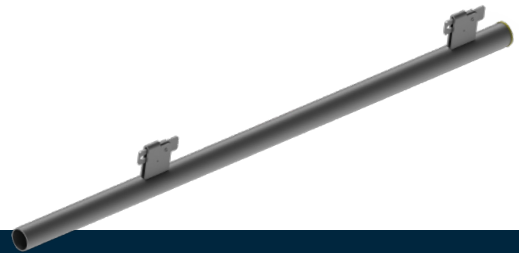

MESH BARRIER 1.3m

SKU: 6210-101004

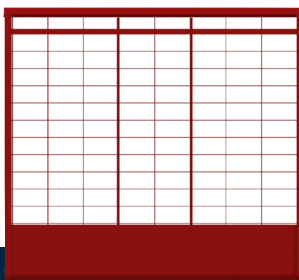

MESH BARRIER 2.6m

SKU: 6210-101003

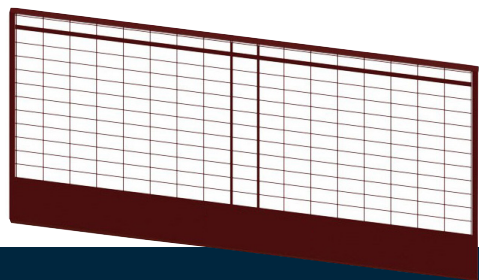

The sheet pile clamp has screw jacks welded to the body to ensure that it can be adapted to fit all standard sheet pile sizes in the market. TG sheet pile clamp system combines with sheet pile clamps which fixed the sheet piles, TG posts 1.9m or 1.3m, TG sliders, and TG Mesh barrier 2.6m or TG mesh barrier 1.3m.

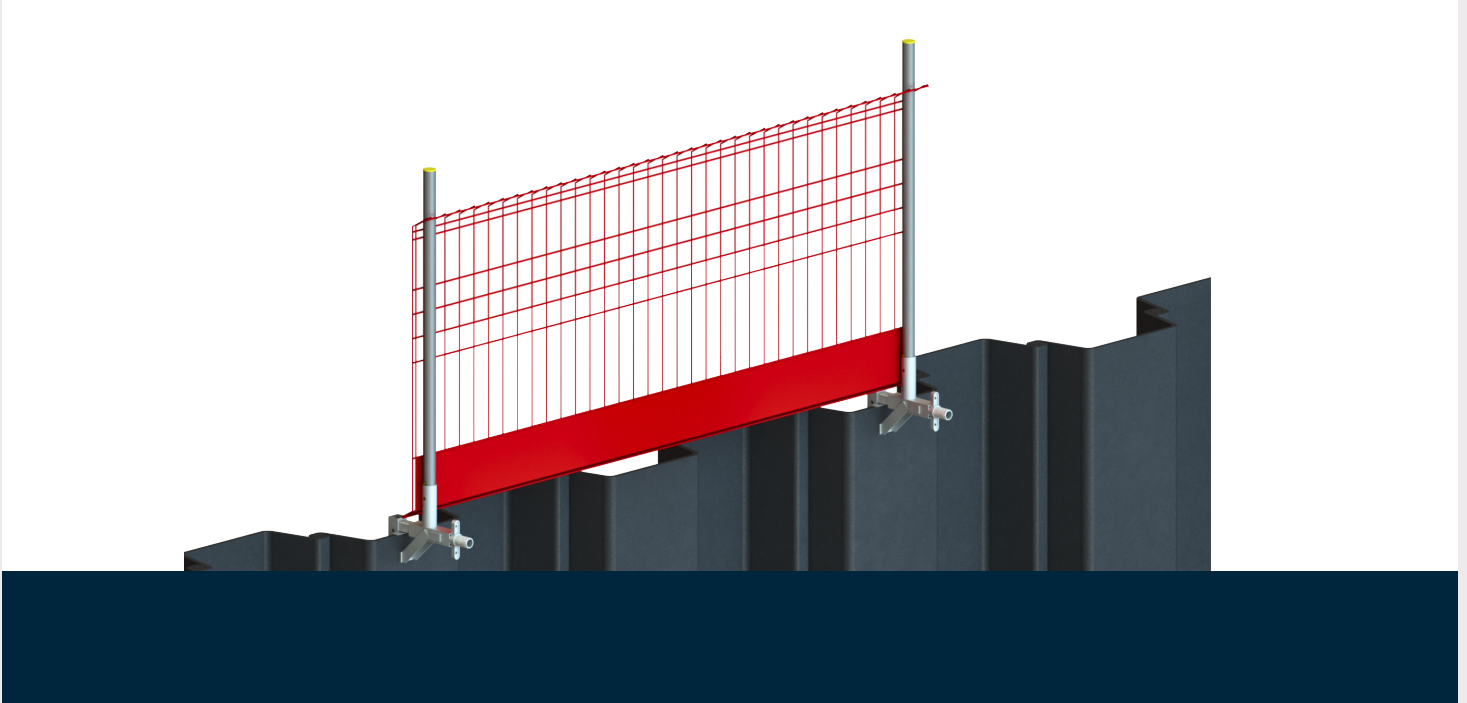

MESH BARRIER 2.6m

SKU: 6210-101023

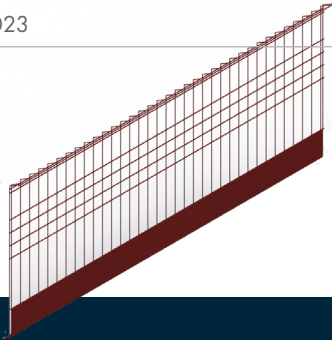

MESH BARRIER 1.3m

SKU: 6210-101024

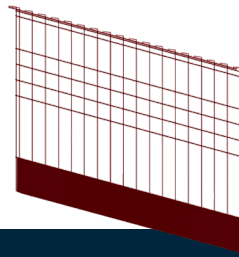

TG POST 1.9m

SKU: 6210-101013



SHEET PILE CLAMP

SKU: 6210-106004



SLIDER (BARRIER CLIP)

SKU: 6210-105003



The sheet pile clamp is also available for trench boxes, it has screw jacks welded to the body to ensure that it can be adapted to fit trench boxes from 1mm to 160mm in width.

Combined with Powerpac safedge post 1.2m, safedge mesh barrier 2.6m, or safedge mesh barrier 1.3m, Safedge trench guard system offers the best fall protection solutions for excavation and groundworks.

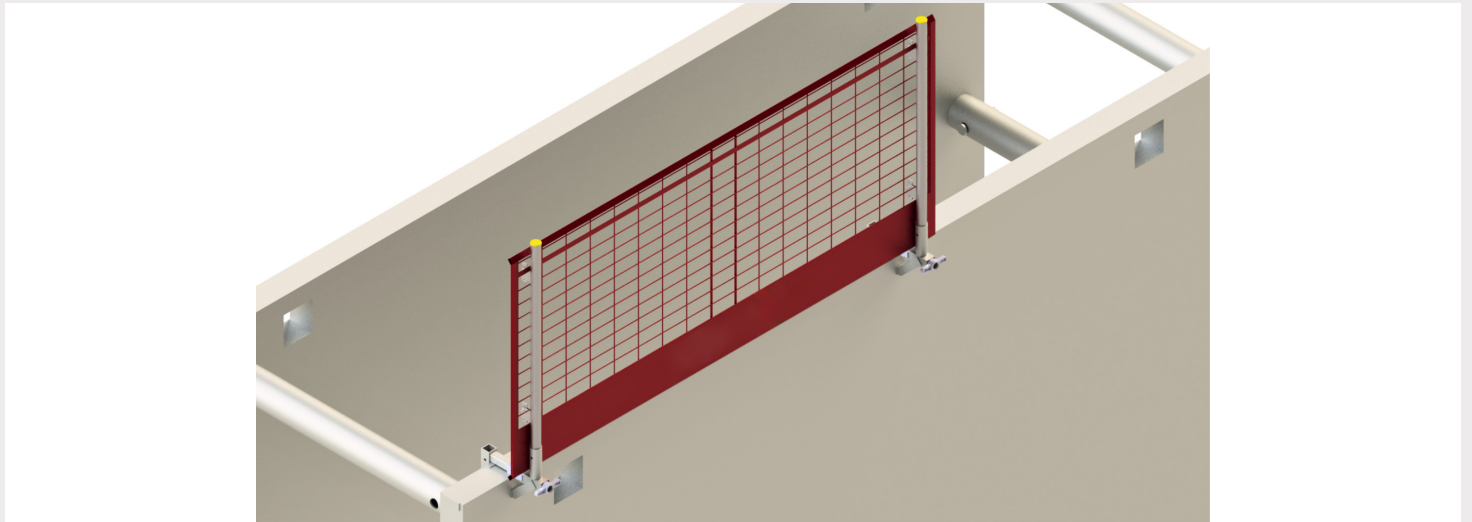

SHEET PILE CLAMP

SKU: 6210-106004



MESH BARRIER 2.6m

SKU: 6210-101003

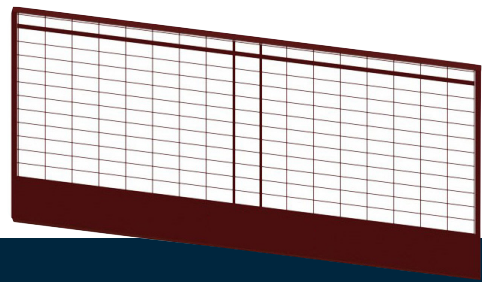

SAFEDGE POST 1.2m

SKU: 6210-101002



MESH BARRIER 1.3m

SKU: 6210-101004

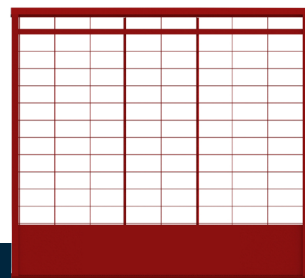

TG trench guard system is another option for fall protection for excavation and groundwork.

Thanks to the multi-purpose mechanism design of the sheet pile clamp, it can be easily fixed on trench boxes with a maximum thickness of 160 mm.

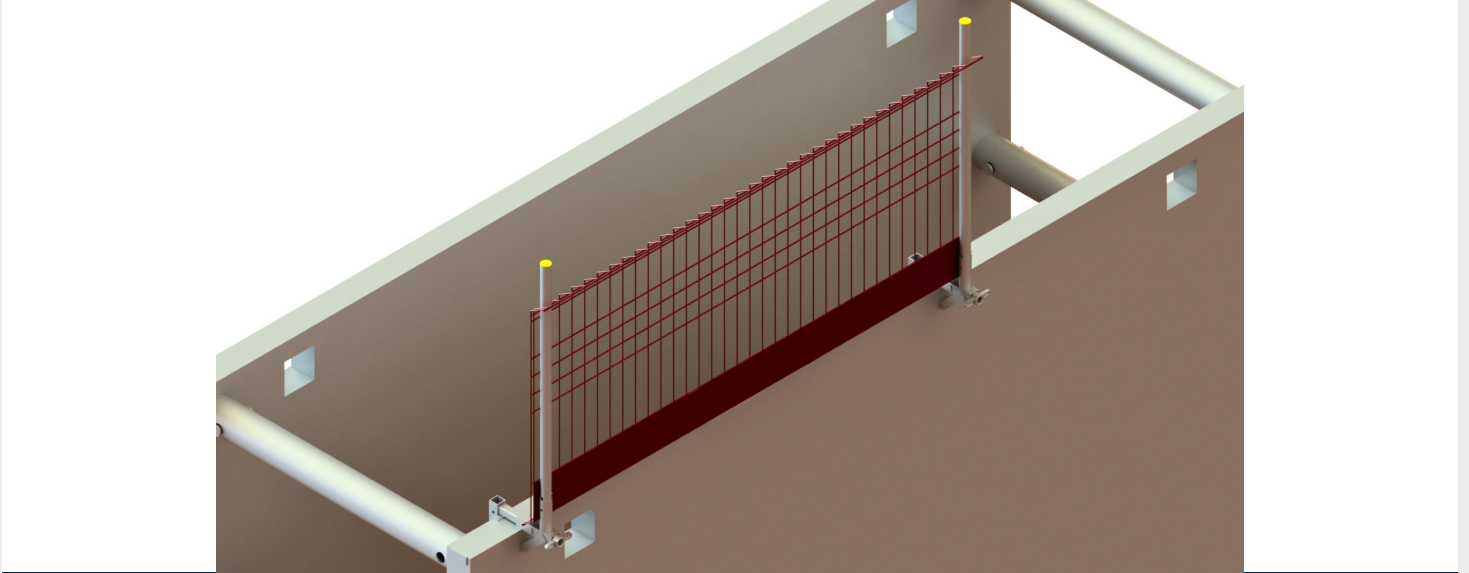

MESH BARRIER 2.6m

SKU: 6210-101023

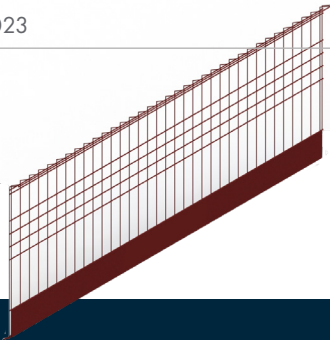

MESH BARRIER 1.3m

SKU: 6210-101024

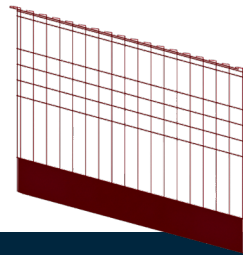

TG POST 1.9m

SKU: 6210-101013



SHEET PILE CLAMP

SKU: 6210-106004

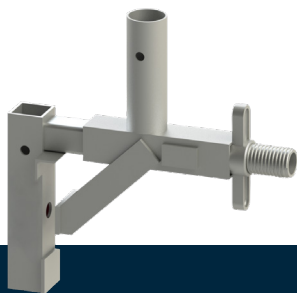

SLIDER (BARRIER CLIP)

SKU: 6210-105003



The Slab Grabber for the Guardrail System is made from Q235 steel material with a powder-coated or galvanised surface treatment.

The Slab Grabber can be adjusted to fit concrete beams from 3" to 36" thick.

Allowable spacing between Slab Grabbers is 2.4m handrails and toe boards for the slab grab guardrail system are 2 x 4 or 2 x 6 construction-grade timber.

The top rail must be 42" (+/- 3") above the working surface following OSHA standards.

For the installation, slab grabbers must be installed flush with the substrate and must allow the guardrail posts to be positioned vertically to the work surface.

Qualified personnel must consider the concrete substrate compatible with the Slab Grabber.

SLAB GRAB

SKU: 6101-101009

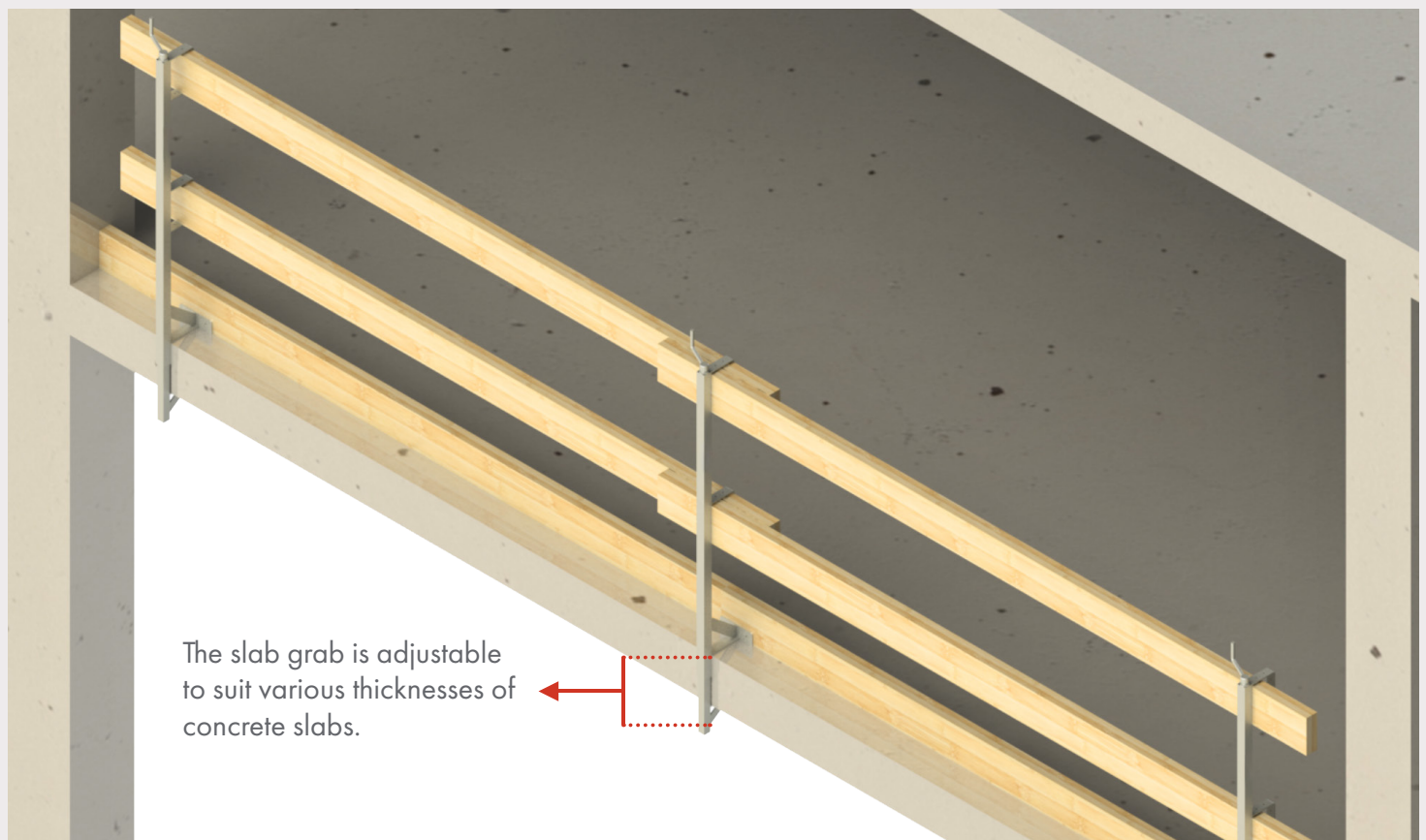
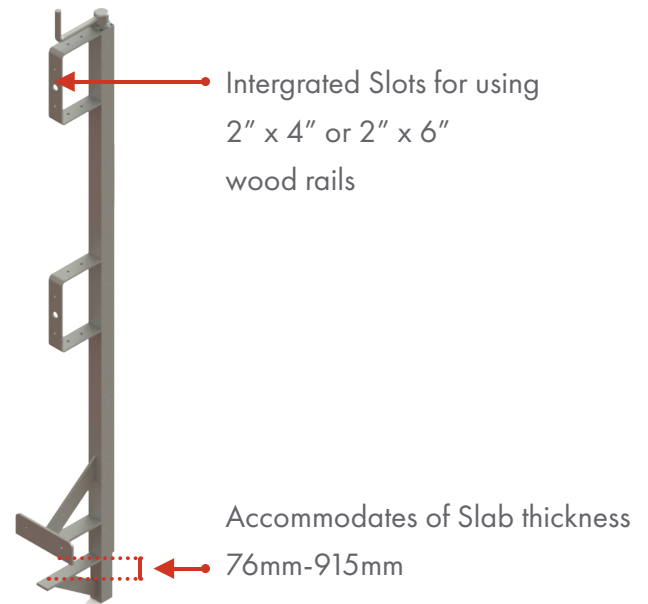

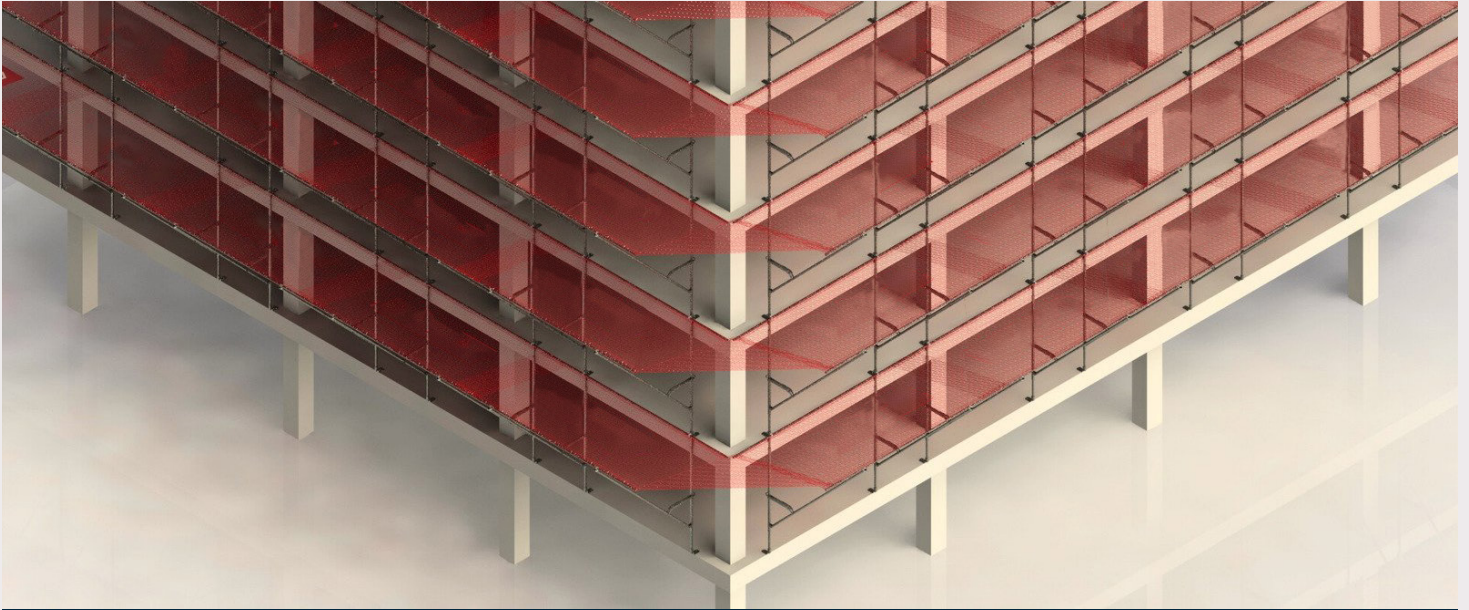

The SAFEDGE Safety Net Fan is a collective slab edge protection system for building construction to prevent or limit the fall of people and materials from height.

The elasticity of the system means that if the net receives an impact, it forms a collection bag around the trapped mass, reducing the impact of the fall and preventing it from falling outside the system.

We developed the Safedge Safety Net Fan to protect workers and the public from the risk of falling objects on construction sites.

Made of high-tensile polypropylene and without knots, our nets are a new concept in safety netting.

The Safedge Safety Net Fan fixes various building shapes, facades, and wind-exposed structures. The frames are designed to British, EN, and American standards.

COMPONENTS:

- Top Bracket
- Bottom Bracket
- Lock Bracket
- Telescopic Post
- Debris Net 3.1 m x 6m
- Horizontal Tube 4.0, 6.0m
- Double Coupler
- Brace Tube 4.50m
- Swivel Coupler



SOCKET BASE

SKU: 6210-101001

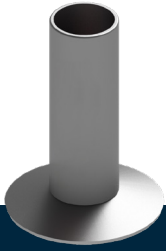

SAFEDGE POST 1.2m

SKU: 6210-101002



MESH BARRIER 2.6m

SKU: 6210-101003

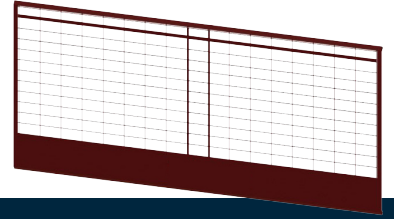

MESH BARRIER 1.3m

SKU: 6210-101004

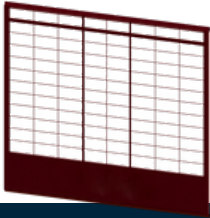

EXTENSION POST

SKU: 6210-101005



EXTENSION MESH BARRIER 2.6m

SKU: 6210-101006

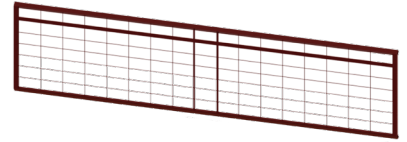

EXTENSION MESH BARRIER 1.3m

SKU: 6210-101007

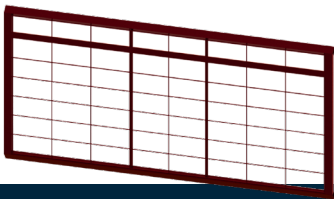

MULTI SLAB CLAMP

SKU: 6210-101008

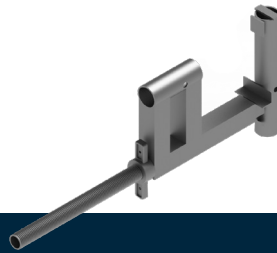

SLAB GRAB

SKU: 6210-101009



TG FOOT

SKU: 6210-101001



EDGE BRACKET

SKU: 6210-101011



POST 1.3m

SKU: 6210-101012



**POST
1.9m**

SKU: 6210-101013

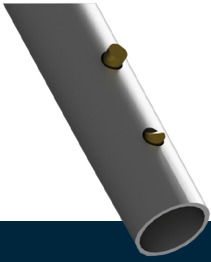

**SIMPLE PACKING
BARRIER CRATE**

SKU:

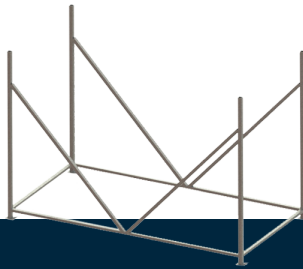

**STANDARD BARRIER
CRATE**

SKU:

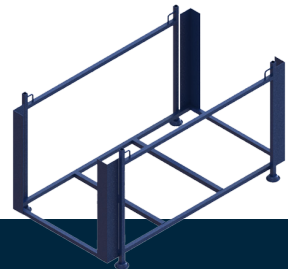

**POST
CRATE**

SKU:



**BOX
CRATE**

SKU:



**STAIR
CLAMP**

SKU: 6210-101018

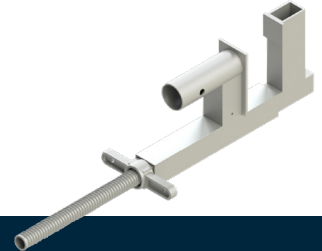

**M16 SLEEVE
ANCHOR**

SKU:

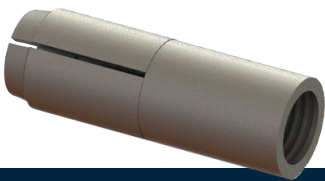

**DOUBLE
THREADED M16**

SKU:



**MULTI
FOOT**

SKU: 6210-101021

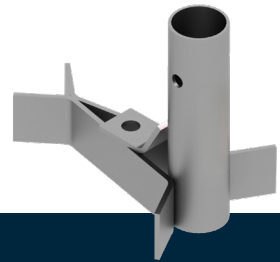

**BRICK
GUARD**

SKU:

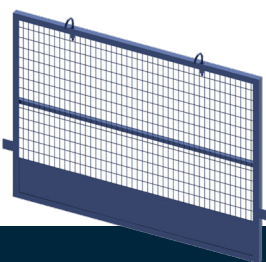

**MESH BARRIER
2.6m**

SKU: 6210-101023

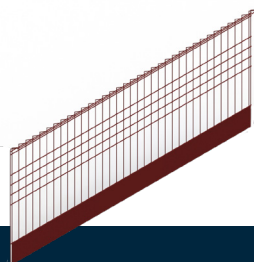

**MESH BARRIER
1.3m**

SKU: 6210-101024

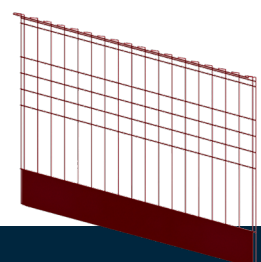

MAKEUP MESH BARRIER 2.6m

SKU: 6210-101025

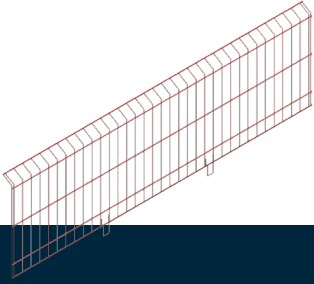

MAKEUP MESH BARRIER 1.3m

SKU: 6210-101026

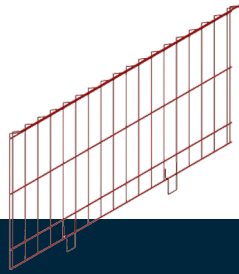

UNKNOWN

SKU: ESB12100G-25



WALKWAY FOOTPLATE

SKU:

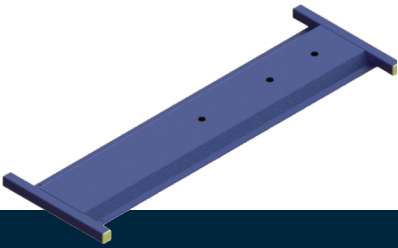

ADJUSTABLE SLAB EDGE BRACKET

SKU: 6210-101032



MESH BARRIER 2.9m

SKU: 6210-101033

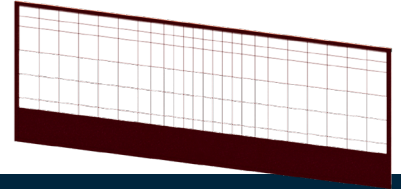

COMPRESSION POST

SKU: 6210-102011



COMPRESSION POST XL

SKU: 6210-102012



COMPRESSION POST CRATE

SKU:

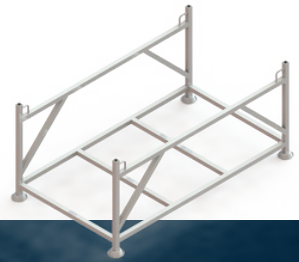

WEDGE COUPLER

SKU: 6210-102050



COMPRESSION POST BARRIER CLIP

SKU: 6210-102060



STEEL I-BEAM CLAMP

SKU: 6210-103001

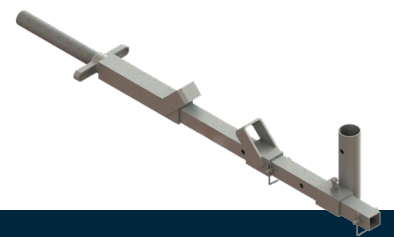

**STEEL I-BEAM
FACADE BRACKET**

SKU: 6210-103002



**EXTENSION
FLUTE 1.2m**

SKU: 6210-103003



**BARRIER BRACKET
360**

SKU: 6210-103004

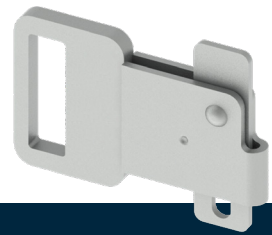

**STAIR MESH
BARRIER**

SKU: 6210-103002

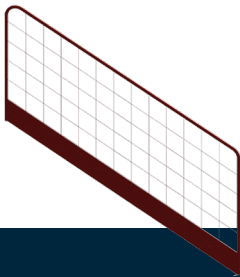

**TG
SLIDER**

SKU: 6210-105003



**ADJUSTABLE LINK
BAR 0.6-0.8m**

SKU: 6210-105004



**ADJUSTABLE LINK
BAR 0.9-1.5m**

SKU: 6210-105005



**ADJUSTABLE LINK
BAR 1.5-2.5m**

SKU: 6210-105006



**ADJUSTABLE LINK
BAR 2.4-3.5m**

SKU: 6210-105007



**ALUMINIUM
BEAM CLAMP**

SKU: 6210-106001

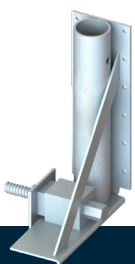

**H2O TIMBER
BEAM CLAMP**

SKU: 6210-106002



**PRIMARY H2O
BEAM SOCKET**

SKU:

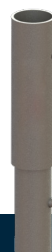

SHEET PILE CLAMP

SKU: 6210-106004

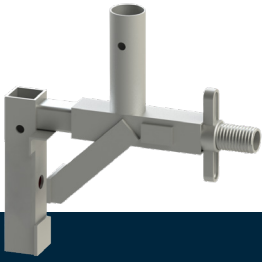

CATCHFAN TOP BRACKET

SKU: 6210-108001



TELESCOPIC POST

SKU: 6210-108002



CATCHFAN LOCK BRACE

SKU:



CATCHFAN BOTTOM BRACKET

SKU: 6210-108004



CATCHFAN HORIZONTAL TUBE 4m

SKU: 6210-AT04

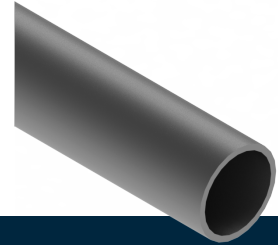

CATCHFAN HORIZONTAL TUBE 6m

SKU: 6210-AT60

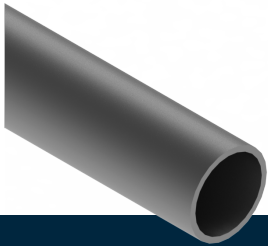

CATCHFAN BRACE TUBE 4.5m

SKU: 6210-AT4.5

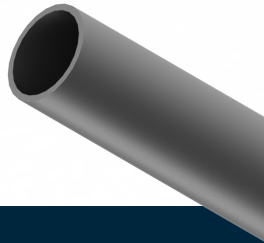

RIGHT ANGLE COUPLER

SKU: FX48

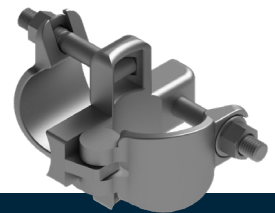

SWIVEL COUPLER

SKU: SW48



4.0m x 3.1m DEBRIS NET

SKU: 6210-108010



6.0m x 3.1m DEBRIS NET

SKU: 6210-108011



SOLUTIONS DELIVERED FAST

Our commitment to you is
"Solutions Delivered Fast".

We're all about putting you first and making sure you have the solutions you need on time to ensure that you keep your project moving.

SITETAXI is our in-house direct to Site Delivery Service.

The Site Taxi Team motto is
"You order it & We'll deliver it".

With over 100,000 stock items across our distribution centres in Auckland, Wellington & Christchurch our Site Taxi Team can keep our promise to you
"Solutions Delivered Fast".



AUCKLAND

SITETAXI DELIVERY ASSETS	SITETAXI SERVICE OPTION	3RD PARTY FREIGHT OPTION	CUSTOMER COLLECTIONS
VAN	Urgent Delivery Service - 2 hr on demand	NZC- next day delivery to main centers	Depot open from 7.30am - 4.30pm
TRUCK 1: 4m deck	Order by 9 am for delivery by 4pm	Mainfreight - 2 - 3 day delivery	
TRUCK 2: 7m deck	Order by 2pm for delivery by 10am		

WELLINGTON

SITETAXI DELIVERY ASSETS	SITETAXI SERVICE OPTION	3RD PARTY FREIGHT OPTION	CUSTOMER COLLECTIONS
VAN	Urgent Delivery Service - 2 hr on demand	NZC- next day delivery to main centers	Depot open from 7.30am - 4.30pm
TRUCK	Order by 9 am for delivery by 4pm	Mainfreight - 2 - 3 day delivery	
HIAB - Crane Truck	Order by 2pm for delivery by 10am		

CHRISTCHURCH

SITETAXI DELIVERY ASSETS	SITETAXI SERVICE OPTION	3RD PARTY FREIGHT OPTION	CUSTOMER COLLECTIONS
UTE	Site Taxi Service available on demand	NZC- next day delivery to main centers	Depot open from 7.30am - 4.30pm
HIAB - Crane Truck	Next Day Delivery	Mainfreight - 2 - 3 day delivery	

Call us **0800 23 57 89**
or Email sales@powerpac.co.nz

